

JARDIBEST

End Suction Centrifugal Pump



info@jardibest.com

Taizhou Beisite Machinery Technology Co., Ltd.

BESITE reserves all the right of products modification without prior notification

CE ISO 9001

End Suction Centrifugal Pump

End Suction Centrifugal Pump



Application

- Water supply systems
- Pressure boosting
- Heating systems for commercial buildings and district heating
- Cooling plants for industrial processing and air-conditioning units
- General transport for industrial processes
- Fire fighting system

Identification Codes

EEP 50-32-130 H(G)/139

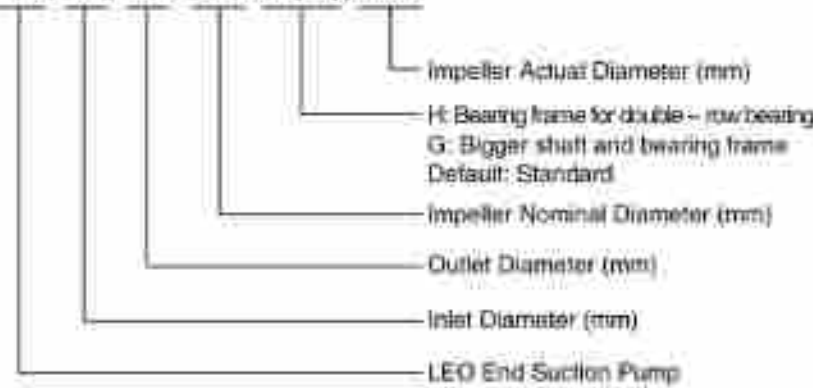

Working Conditions

- Pump design complies to BS EN 733/DIN 24255 standard
- Conveying medium: Low viscosity, non-inflammable and non-explosive liquids not containing solid particles or fibers
- Speed: 1450/2900 rpm at 50 Hz, 1750/3500 rpm at 60 Hz
- Flow range: 0.5 - 440 l/s
- Head range: 2 - 152 m
- Max. liquid temperature: 105°C
- Liquid pH value: 4 - 10
- Max. operation pressure: 10 bar, 16 bar on request

Design & Structure

Design	Performance and dimensions referring to the European standard BS EN733/DIN24255
Structure	Horizontal, Axial End-Suction, Single-Stage, Single-Suction, Volute Casing, Back pull-out
DN(mm)	Inlet: 50-350 Outlet: 22-300
Flange	ISO7005.2, DIN2501 PN10, GB/T17241.0 PN1.0

Materials Table

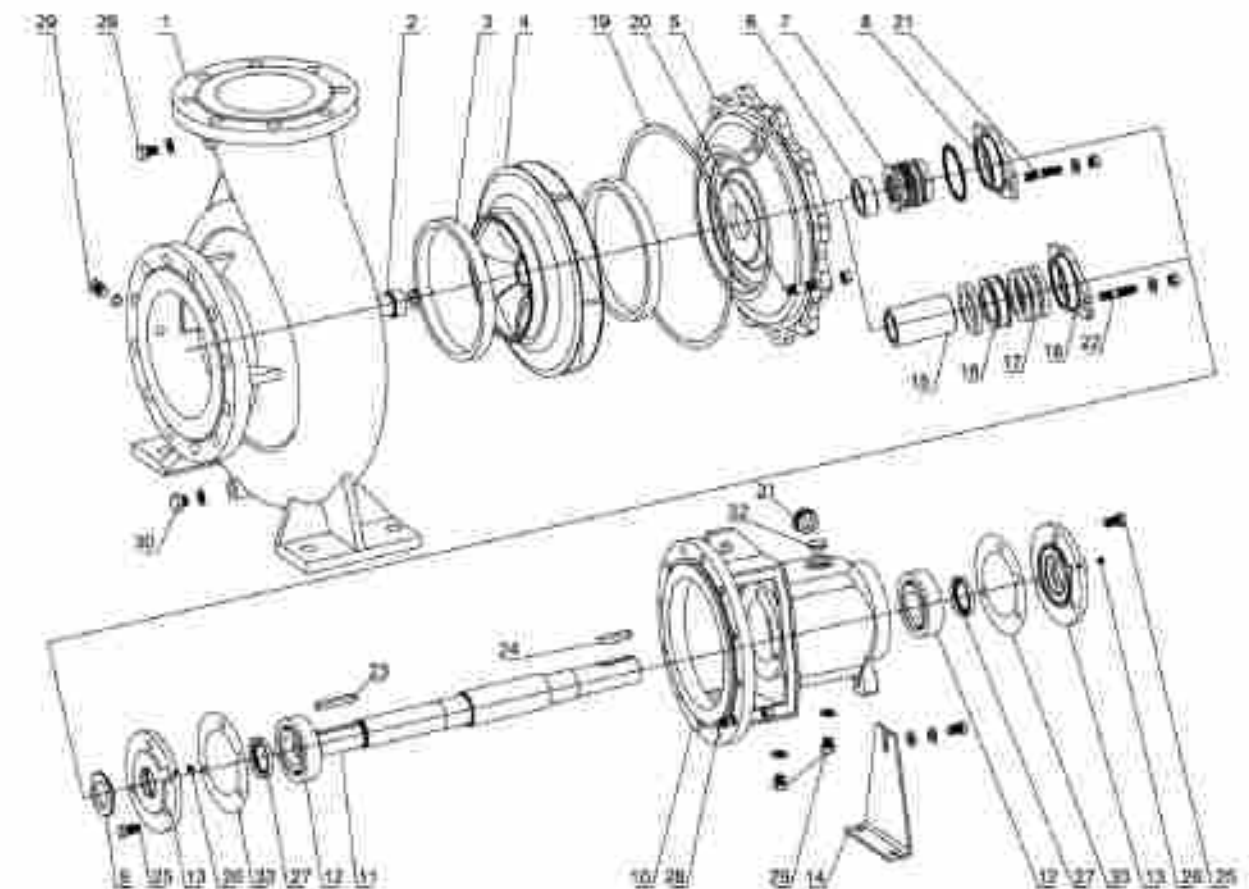

Materials Table

No.	Part	Material	No.	Part	Material	No.	Part	Material
1	Pump casing	Cast Iron(Standard) Ductile Iron 304010	12	Bearing		23	Key	
2	Impeller nut		13	Bearing cover		24	Key	
3	Wear ring		14	Support foot		25	Bolt	
4	Impeller	Cast Iron(Standard) Brass/Bronze 304010	15	Packing sleeve	Bronze	26	Oil nipple	
5	Casing cover		16	Packing seal cage		27	Oil seal	
6	Shaft spacer	2013(Standard) 304010	17	Gland packing		28	Nut	
7	Shaft seal	Mechanics seal(Standard) Packing seal	18	Gland cover		29	Washer	
8	Star cover		19	Gasing gasket		30	Washer	
9	Rubber string		20	Nut		31	Oil scale	
10	Bearing frame		21	Nut		32	Oil cover	
11	Shaft	2013(Standard) 304010	22	Nut		33	Bearing cover gasket	

Characteristic Curves

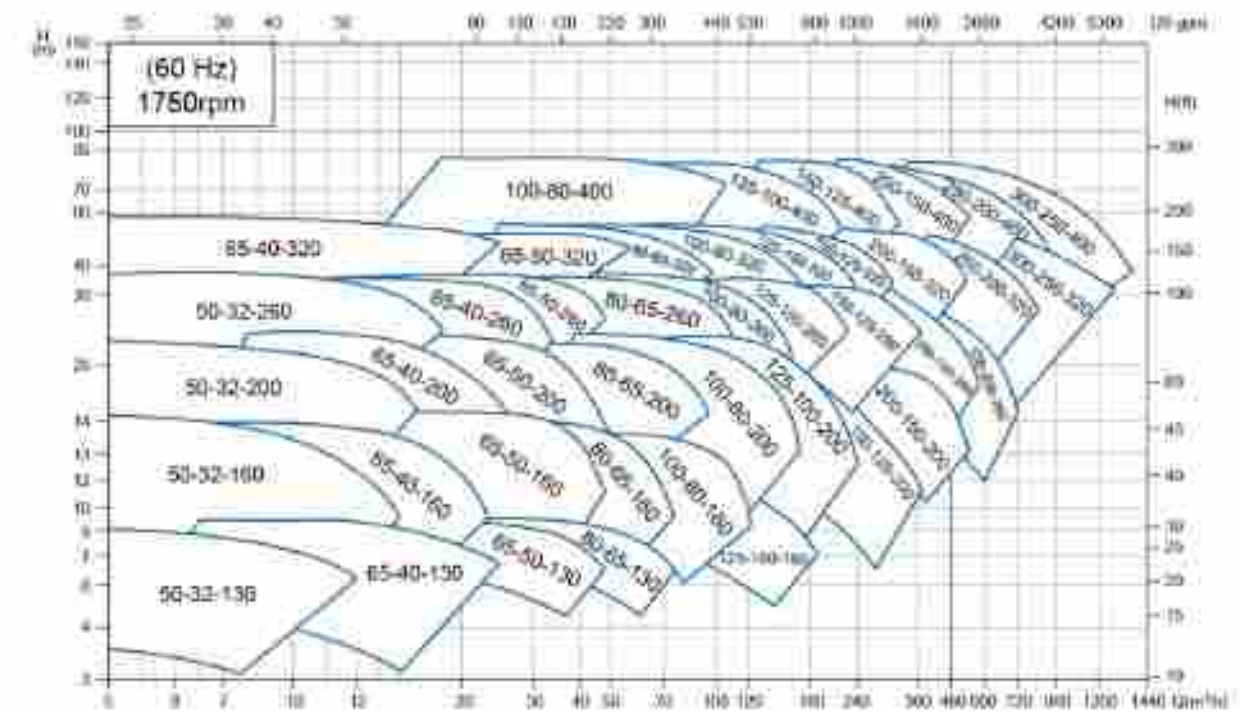
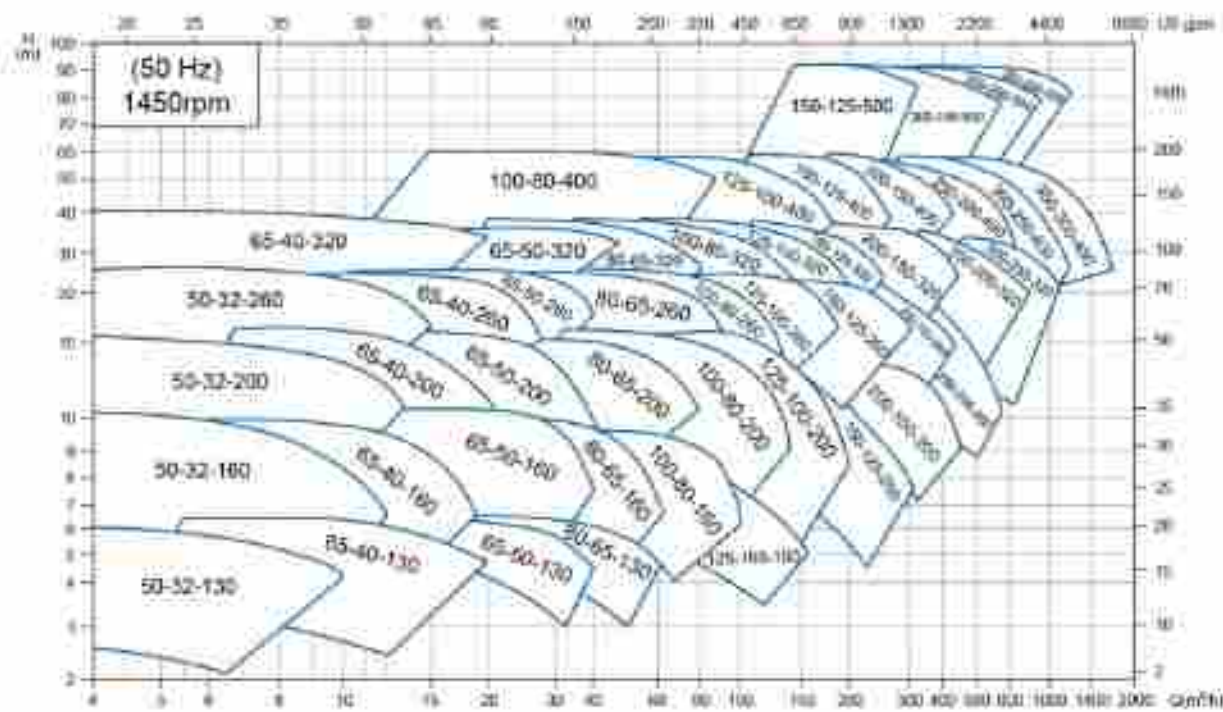
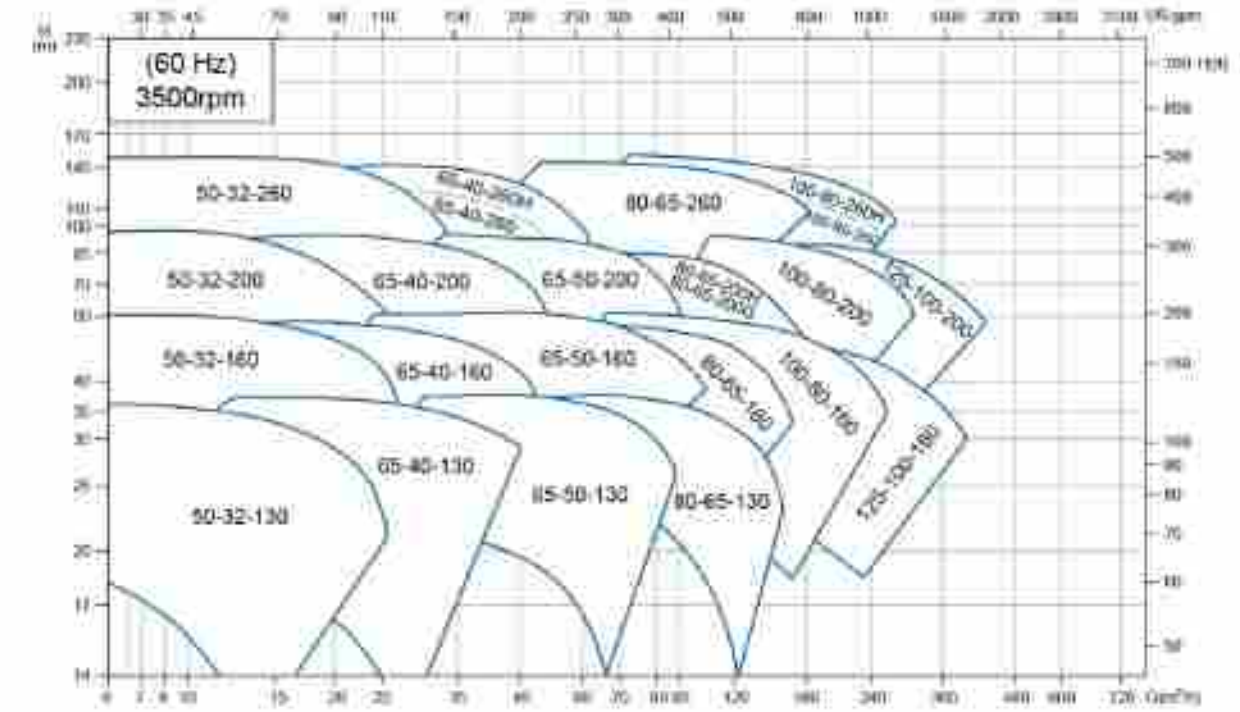
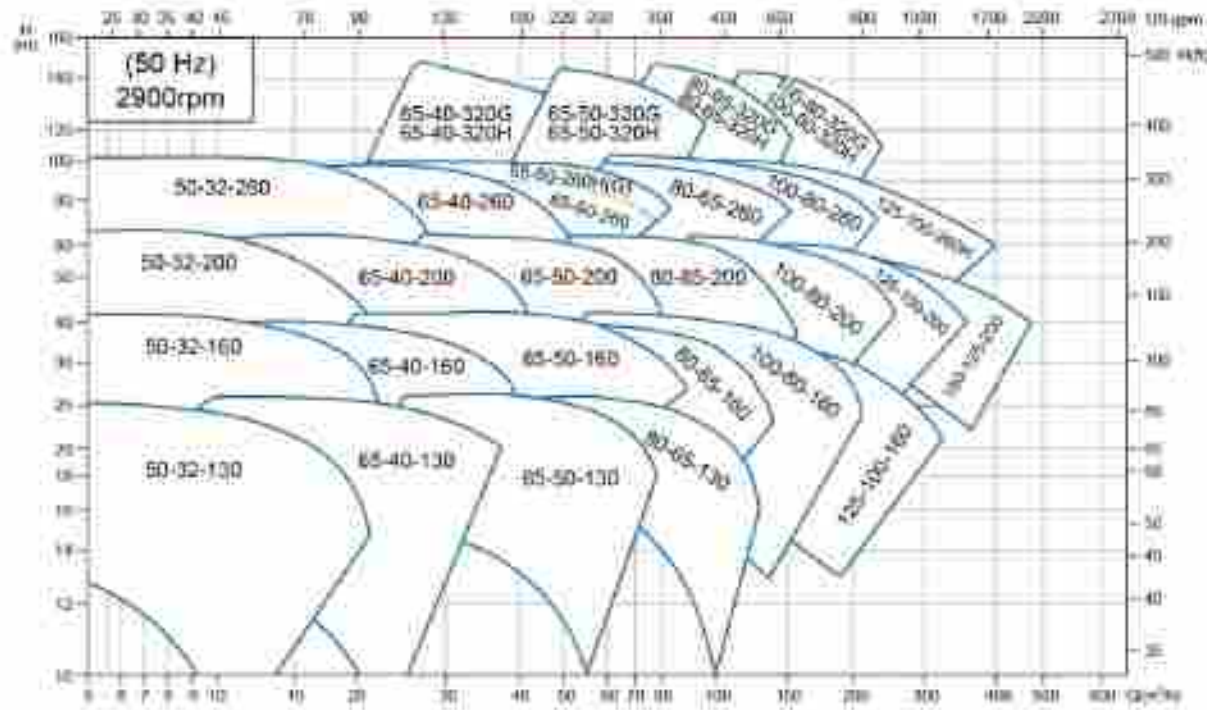

Installation Dimensions

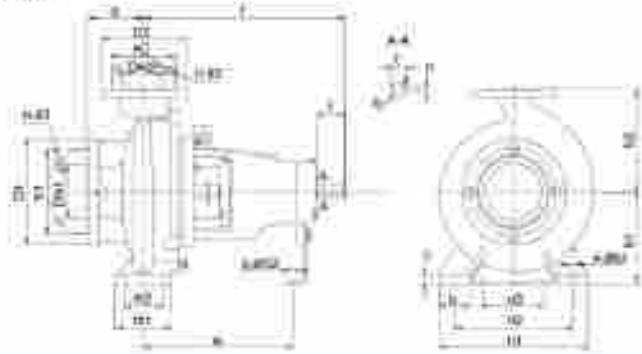

Model	Shaft ID (mm)	DN2	DN1	z	T	HT	HD	D	E	HT	HD	HT	HD	S1	S2	W	D	L	T	H	Weight (kg)
EEP60-32-50	25	32	50	40	112	170	58	14	182	100	70	200	180	14	14	262	24	00	27	8	29
EEP60-32-100					112	190	58														47
EEP60-32-200					112	190	58														47
EEP60-32-300					112	190	58														47
EEP60-40-50	25	40	50	40	132	190	58	14	100	70	200	180	14	14	262	24	00	27	8	34	
EEP60-40-100					132	190	58													45	
EEP60-40-200					132	190	58													45	
EEP60-40-300					132	190	58													45	
EEP60-50-50	25	50	50	40	152	190	58	14	100	70	200	180	14	14	262	24	00	27	8	39	
EEP60-50-100					152	190	58													45	
EEP60-50-200					152	190	58													45	
EEP60-50-300					152	190	58													45	
EEP60-60-50	25	60	50	40	172	190	58	14	100	70	200	180	14	14	262	24	00	27	8	44	
EEP60-60-100					172	190	58													45	
EEP60-60-200					172	190	58													45	
EEP60-60-300					172	190	58													45	
EEP60-80-50	25	80	50	40	192	190	58	14	100	70	200	180	14	14	262	24	00	27	8	49	
EEP60-80-100					192	190	58													45	
EEP60-80-200					192	190	58													45	
EEP60-80-300					192	190	58													45	
EEP60-100-50	25	100	50	40	212	190	58	14	100	70	200	180	14	14	262	24	00	27	8	54	
EEP60-100-100					212	190	58													45	
EEP60-100-200					212	190	58													45	
EEP60-100-300					212	190	58													45	
EEP60-125-50	25	125	50	40	232	190	58	14	100	70	200	180	14	14	262	24	00	27	8	59	
EEP60-125-100					232	190	58													45	
EEP60-125-200					232	190	58													45	
EEP60-125-300					232	190	58													45	
EEP60-150-50	25	150	50	40	252	190	58	14	100	70	200	180	14	14	262	24	00	27	8	64	
EEP60-150-100					252	190	58													45	
EEP60-150-200					252	190	58													45	
EEP60-150-300					252	190	58													45	
EEP60-200-50	25	200	50	40	292	190	58	14	100	70	200	180	14	14	262	24	00	27	8	74	
EEP60-200-100					292	190	58													45	
EEP60-200-200					292	190	58													45	
EEP60-200-300					292	190	58													45	
EEP60-250-50	25	250	50	40	332	190	58	14	100	70	200	180	14	14	262	24	00	27	8	84	
EEP60-250-100					332	190	58													45	
EEP60-250-200					332	190	58													45	
EEP60-250-300					332	190	58													45	
EEP60-300-50	25	300	50	40	372	190	58	14	100	70	200	180	14	14	262	24	00	27	8	94	
EEP60-300-100					372	190	58													45	
EEP60-300-200					372	190	58													45	
EEP60-300-300					372	190	58													45	
EEP60-400-50	25	400	50	40	412	190	58	14	100	70	200	180	14	14	262	24	00	27	8	104	
EEP60-400-100					412	190	58													45	
EEP60-400-200					412	190	58													45	
EEP60-400-300					412	190	58													45	

ISD70652 DN2501 PN16 CE/T17241.1 PN1.6													
DN1/DN2	32	40	50	65	80	100	125	150	200	250			
DN3	140	150	165	180	200	250	285	340	400	500			
KN2	100	110	125	140	160	180	210	240	285	335			
vd17m-2	4-4.18	4-4.18	4-4.18	4-4.18	6-4.18	6-4.18	8-4.18	8-4.20	10-4.22	12-4.26	12-4.26	15-4.26	16-4.30

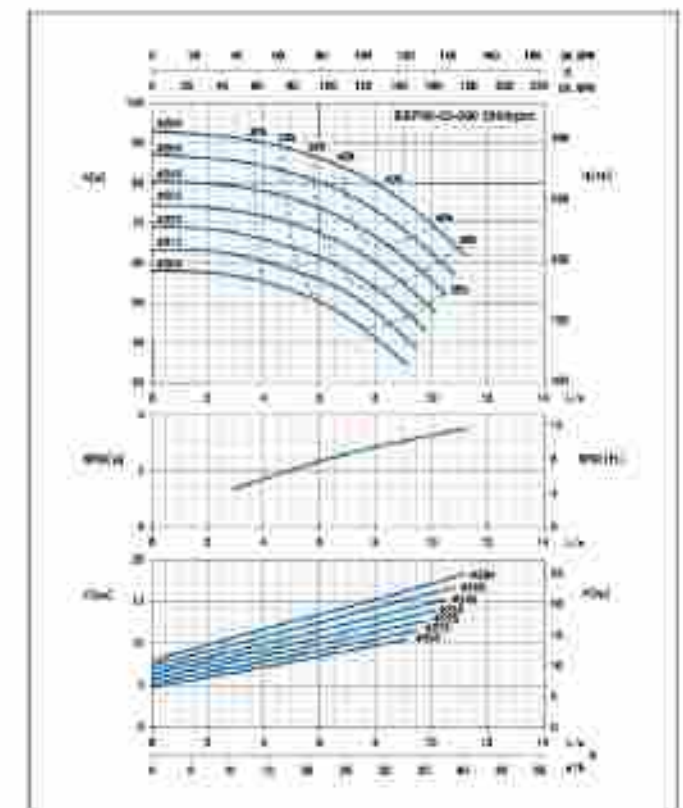
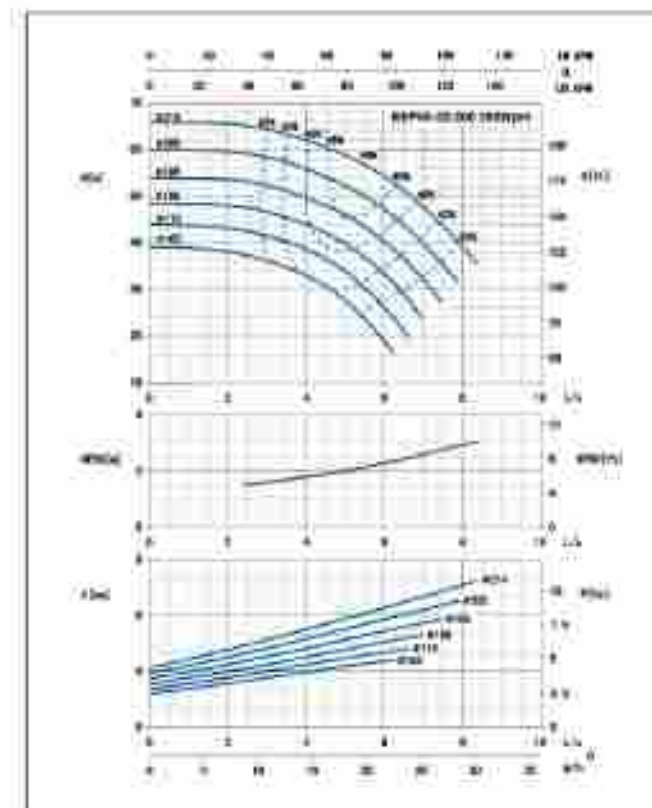
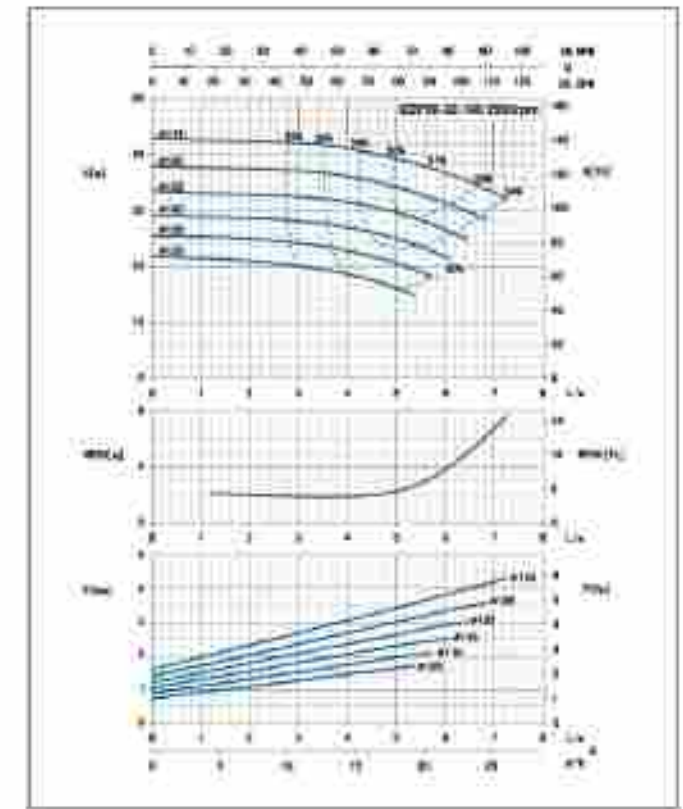
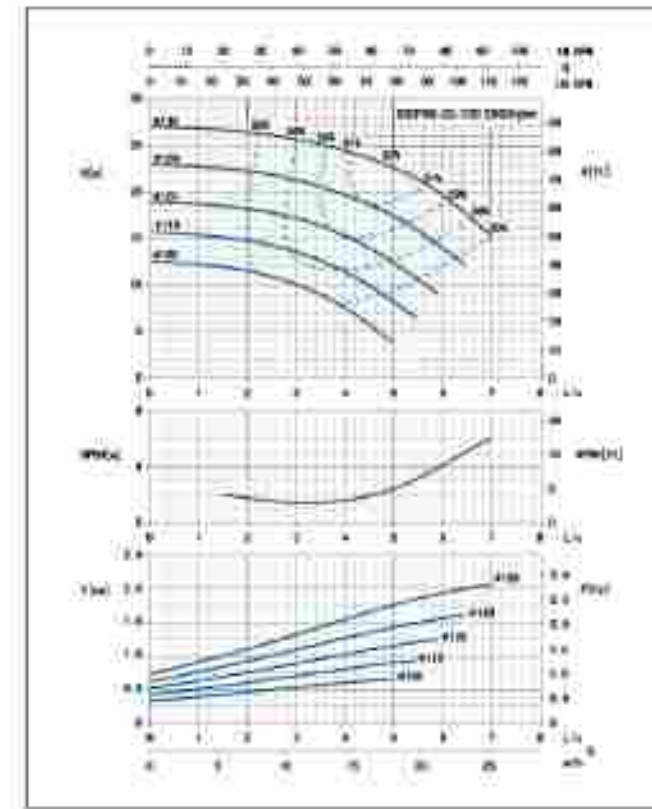

End Suction Centrifugal Pump

End Suction Centrifugal Pump

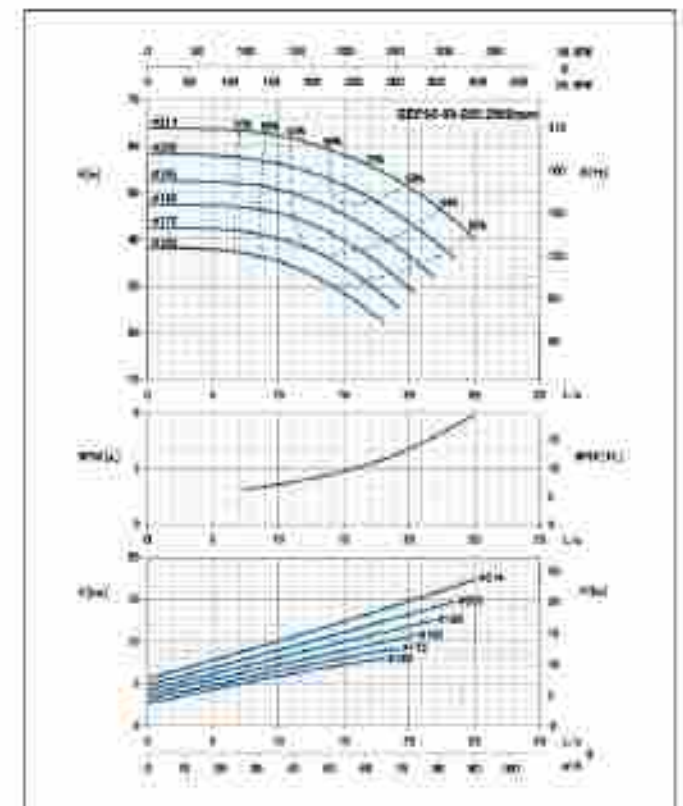
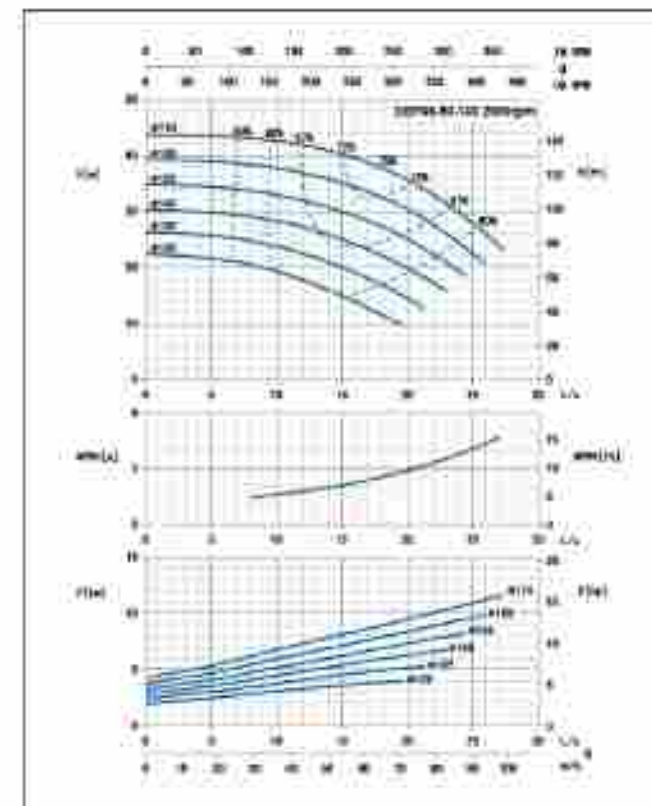
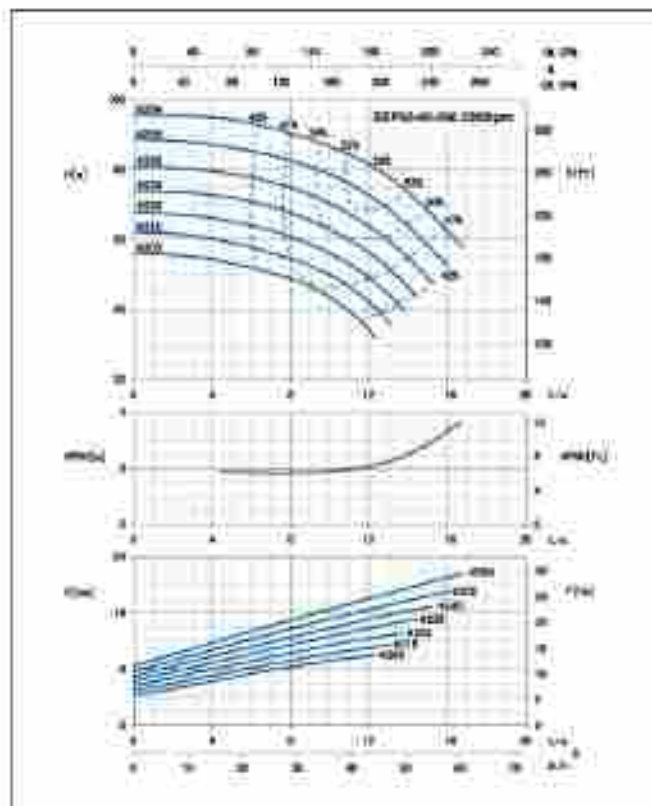
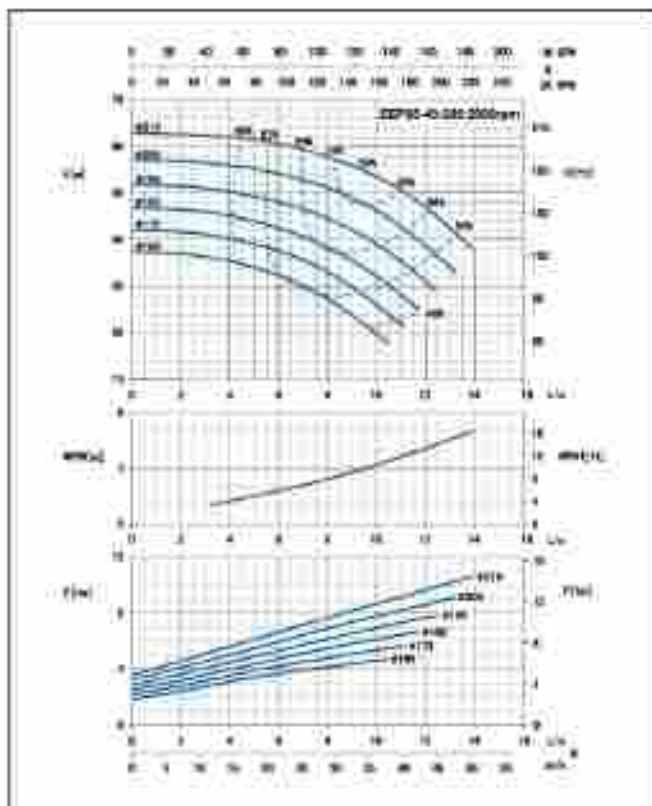
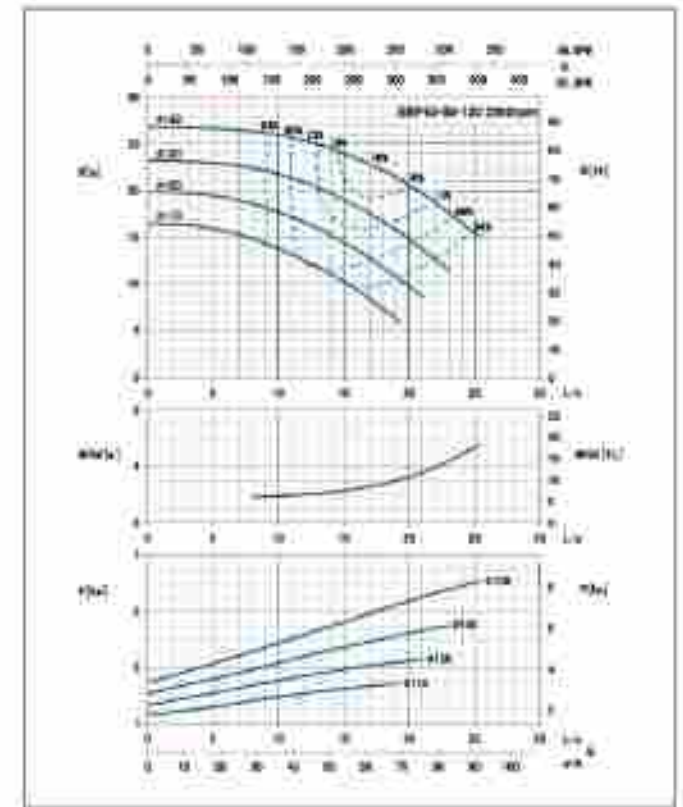
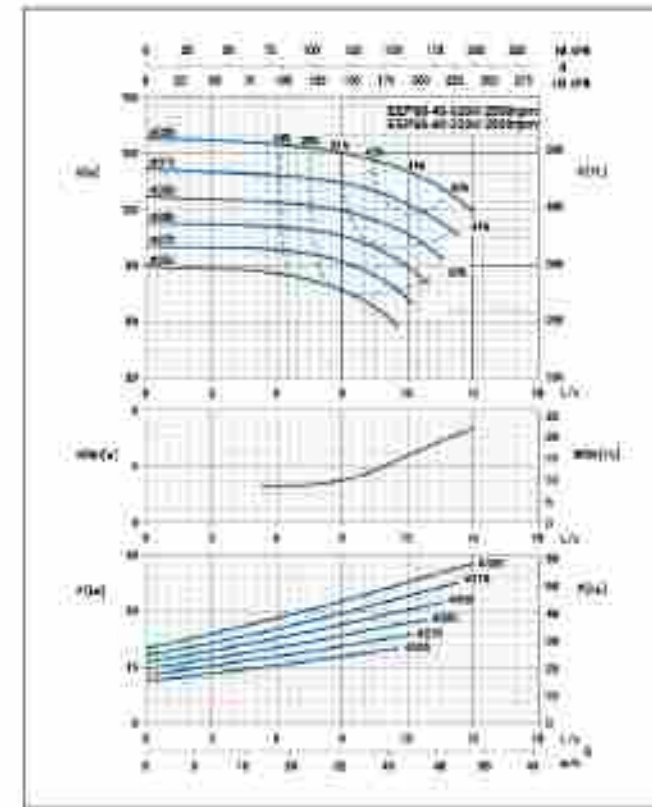
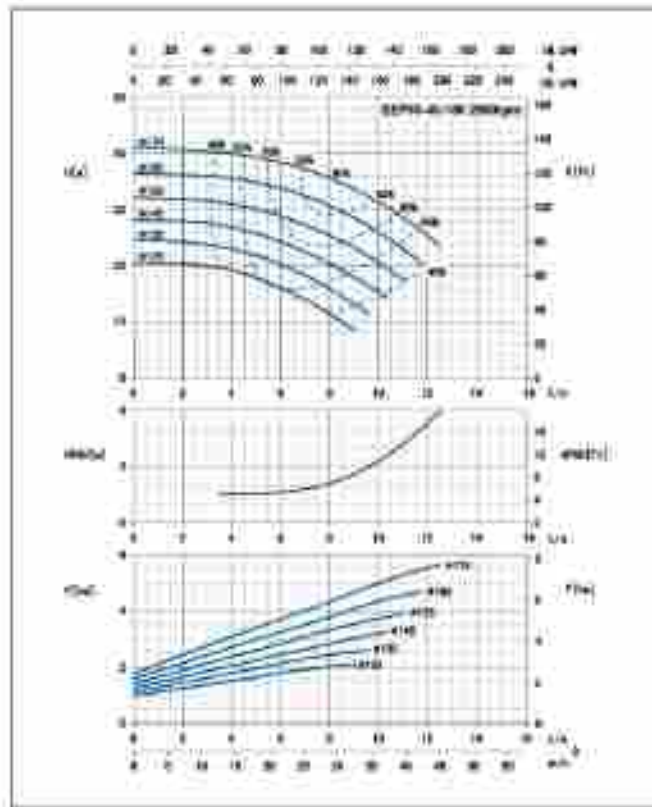
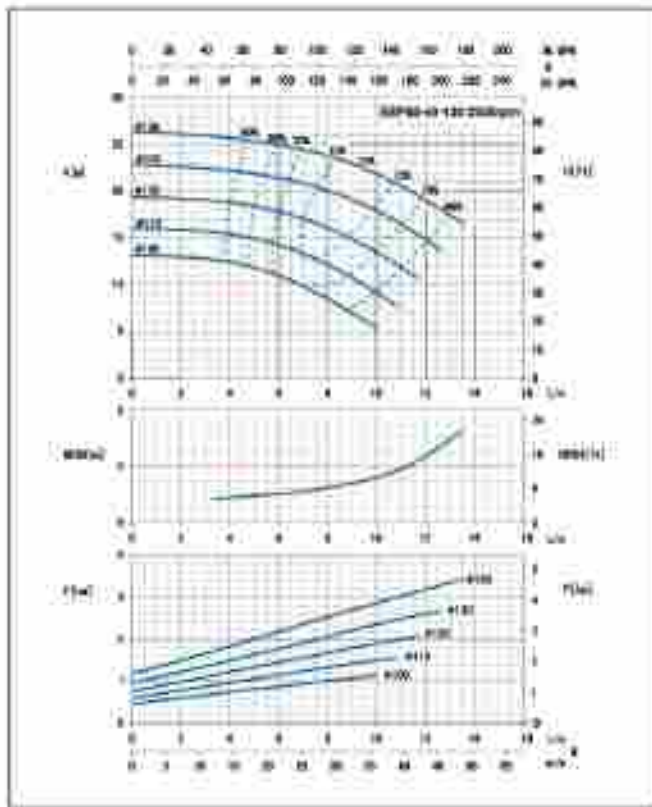

End Suction Centrifugal Pump

End Suction Centrifugal Pump

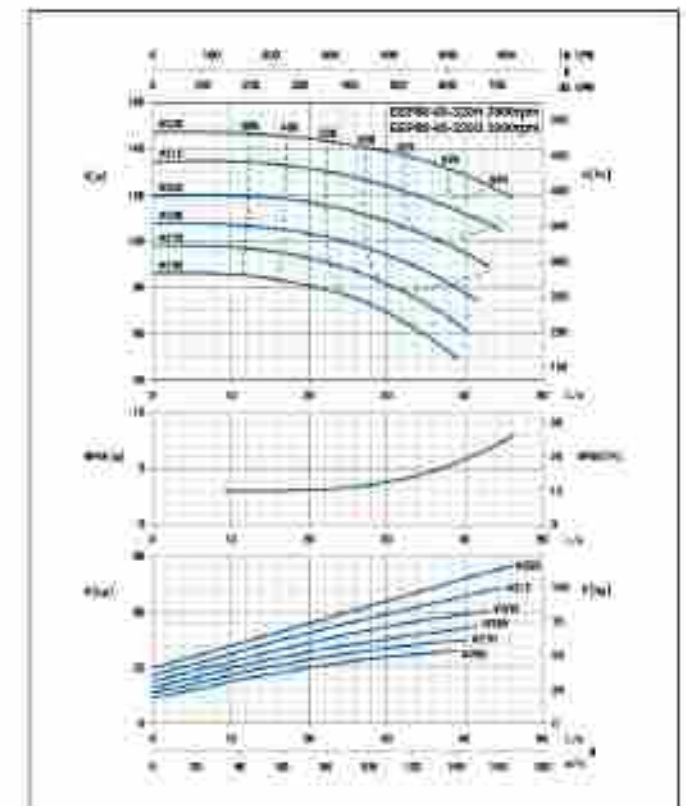
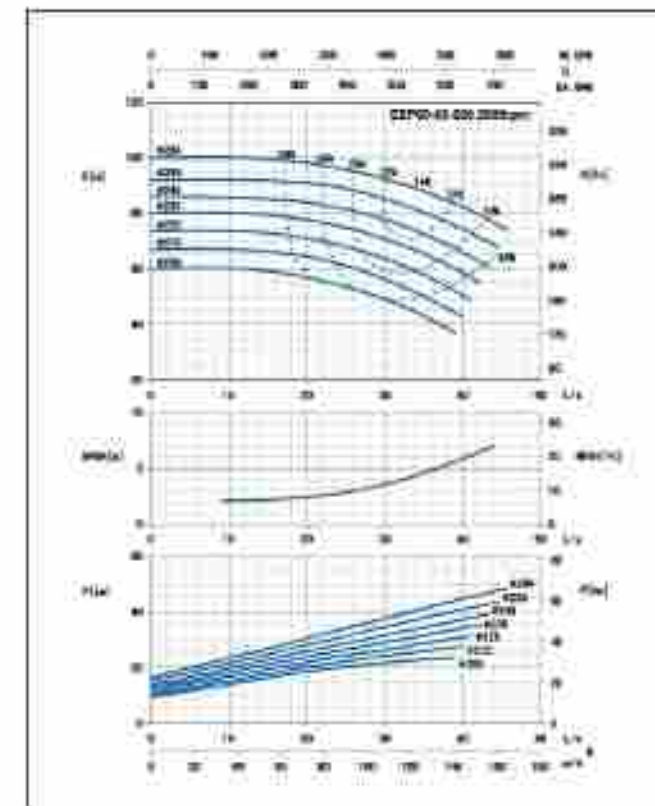
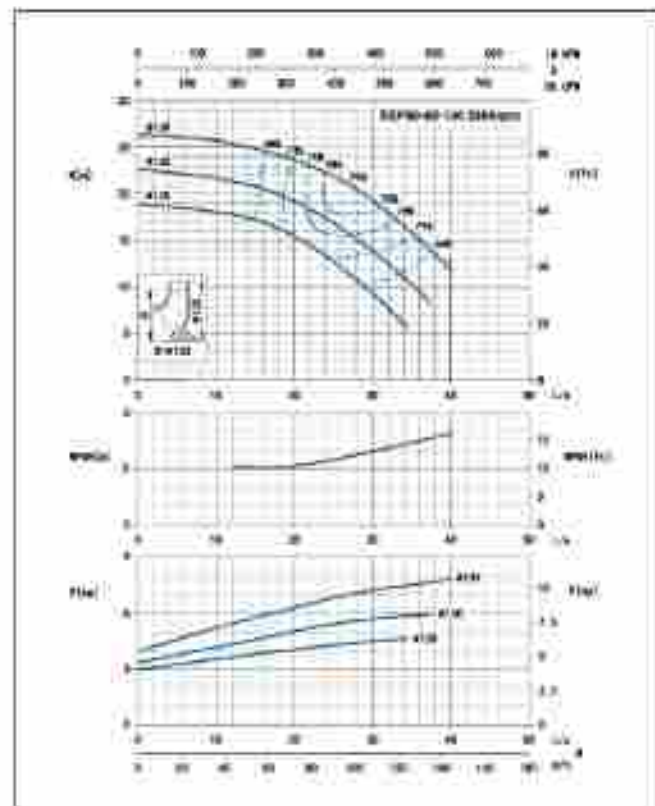
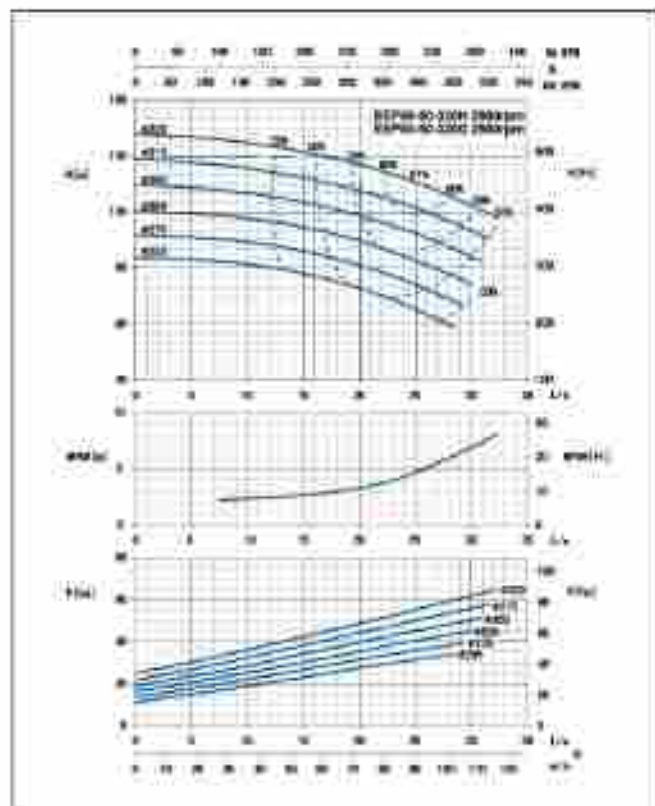
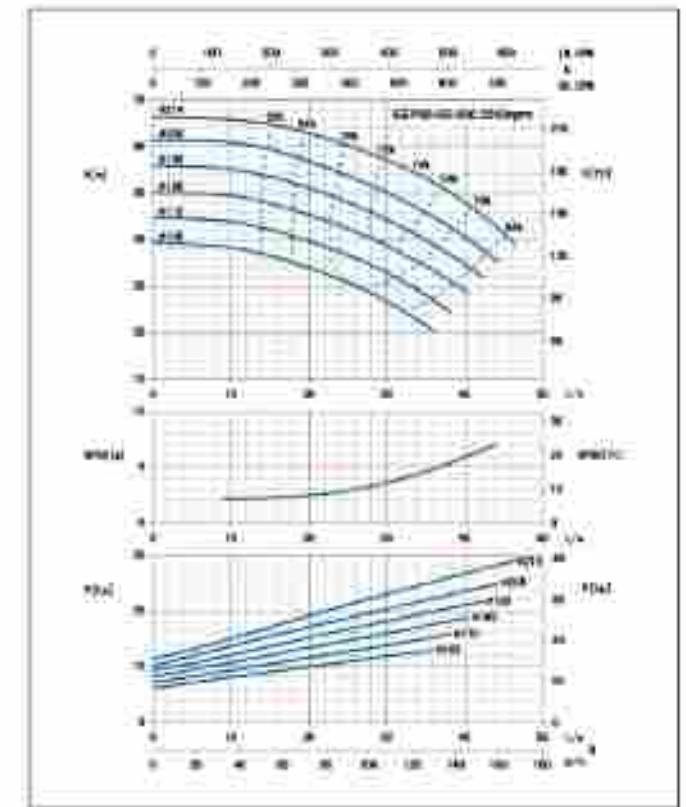
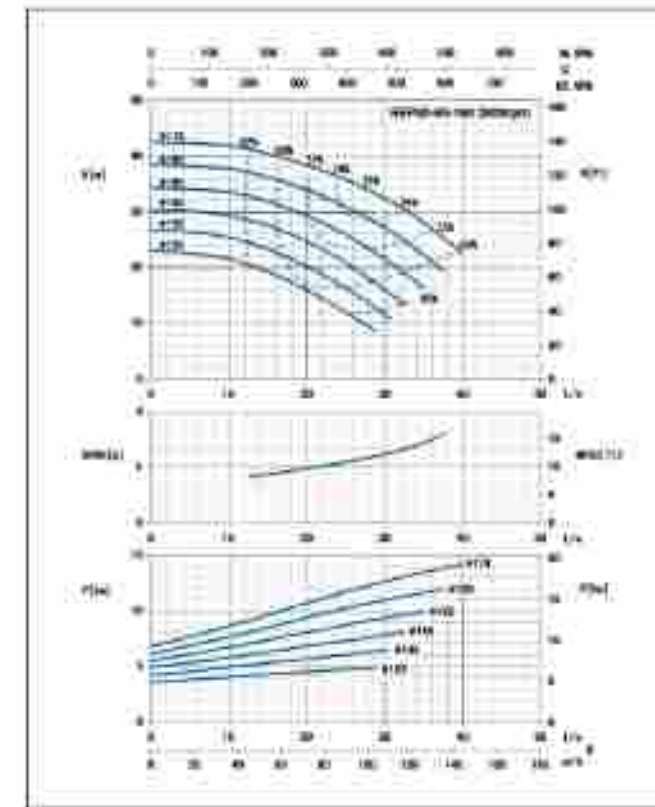
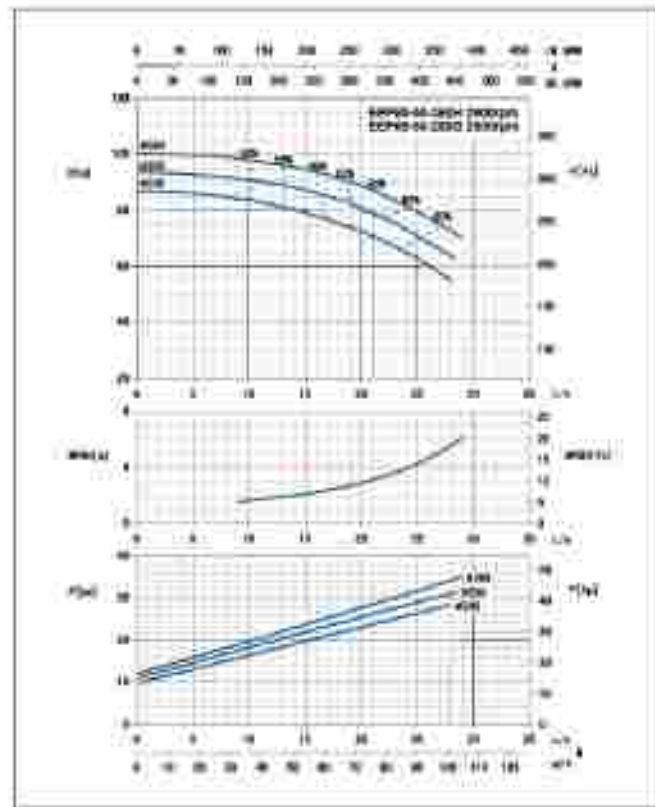
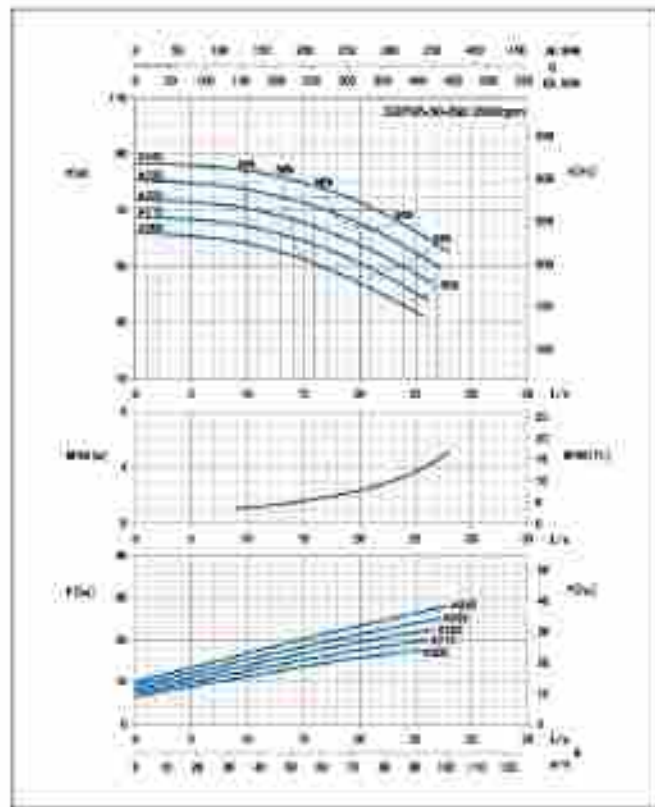

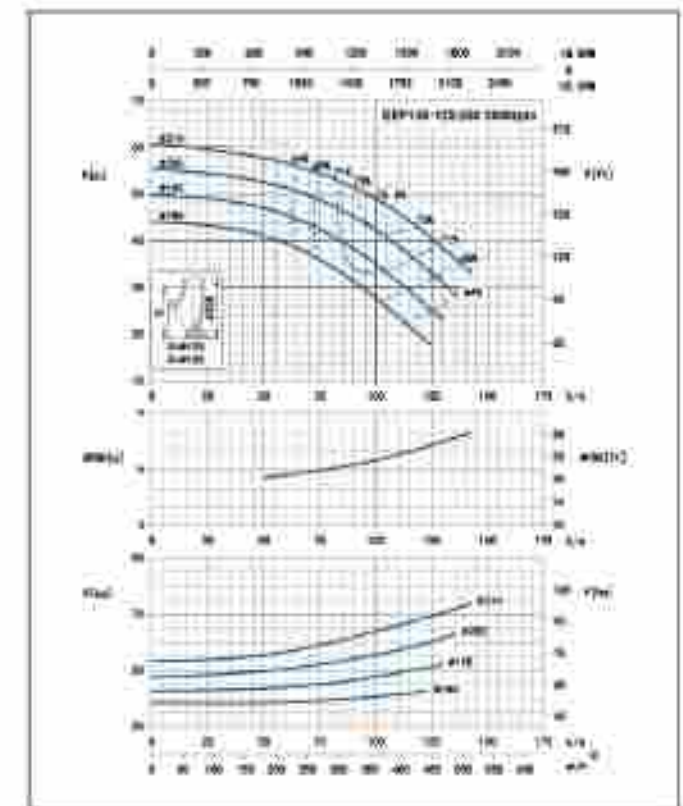
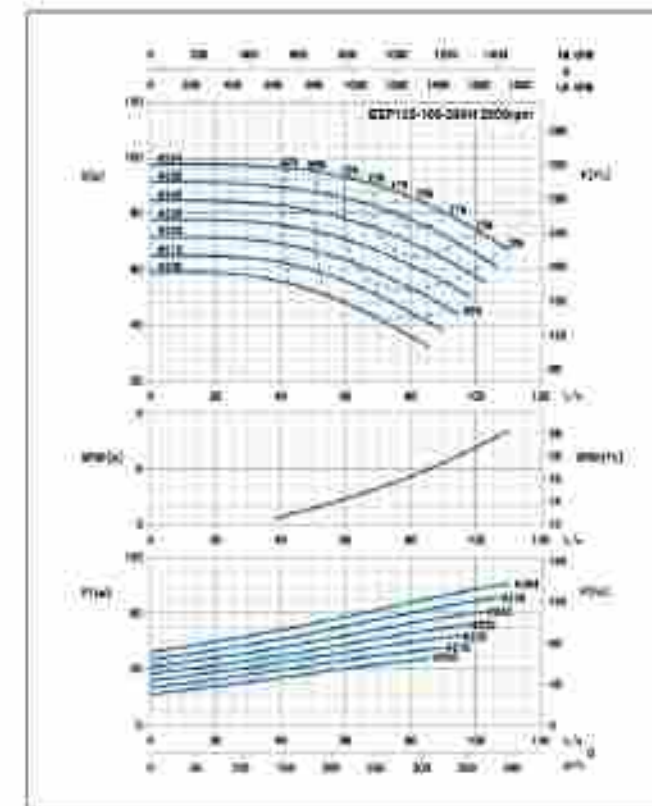
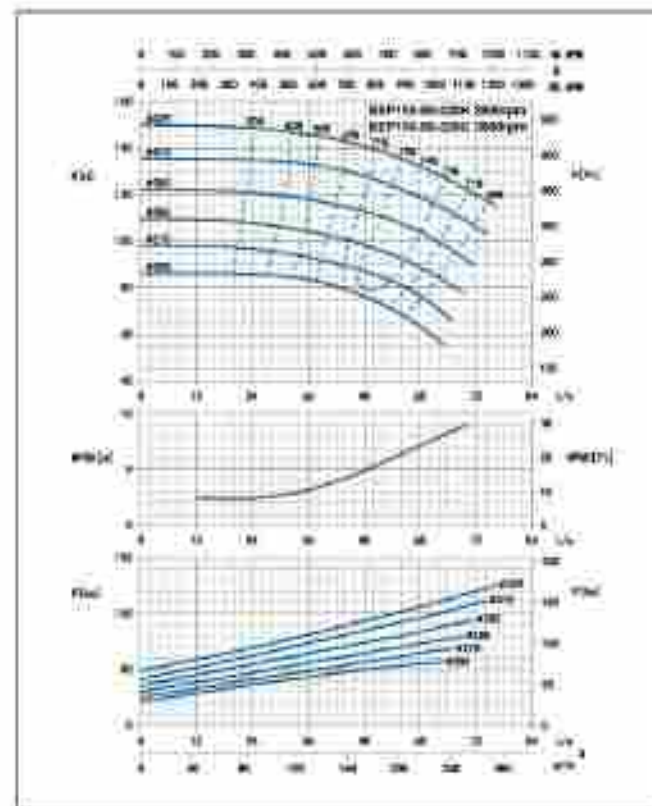
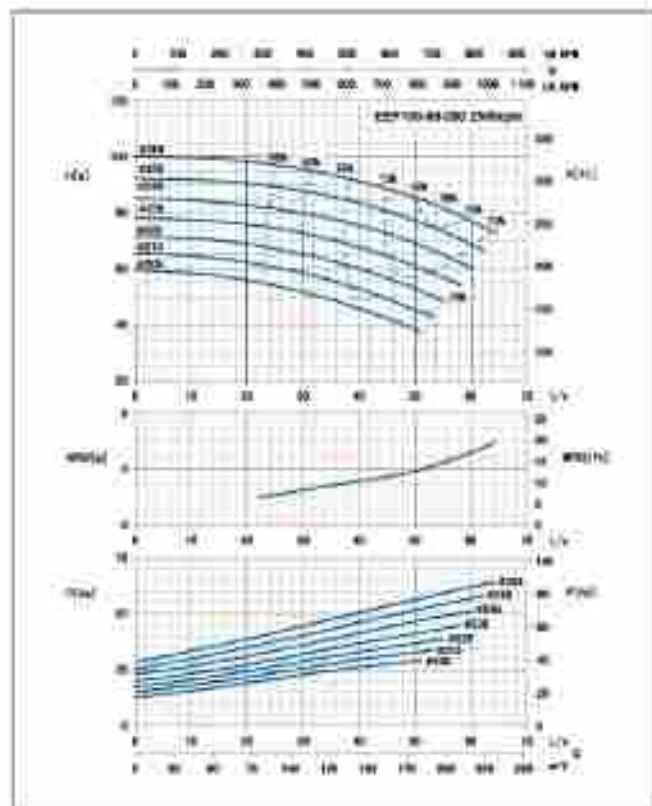
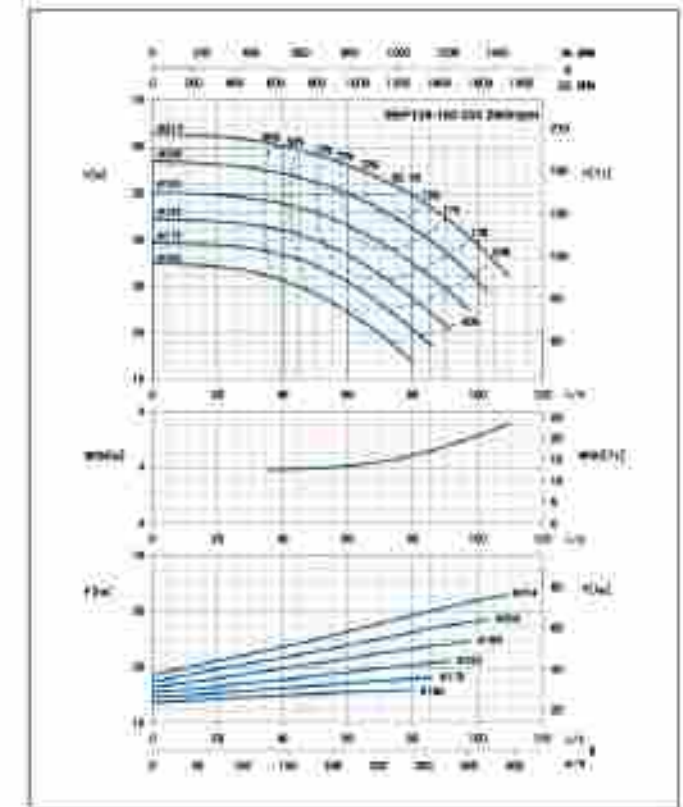
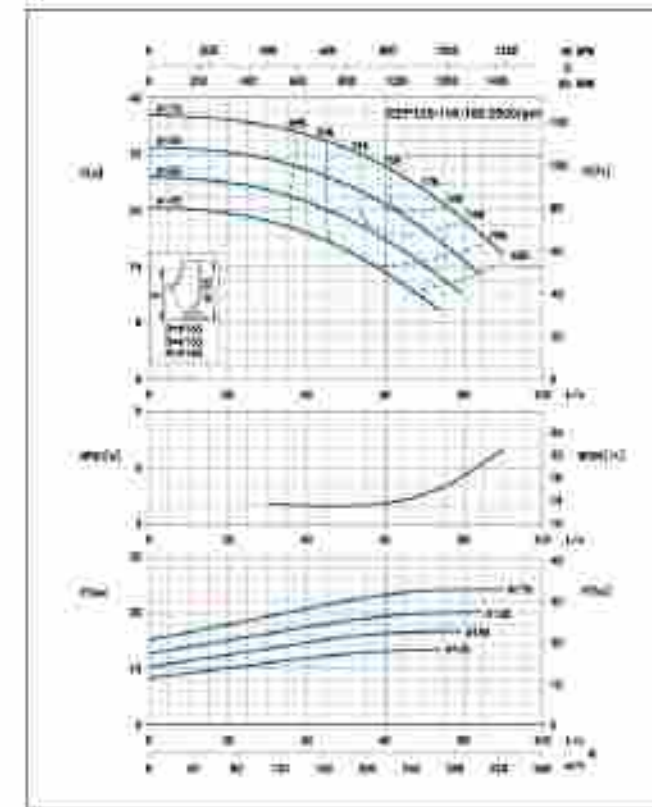
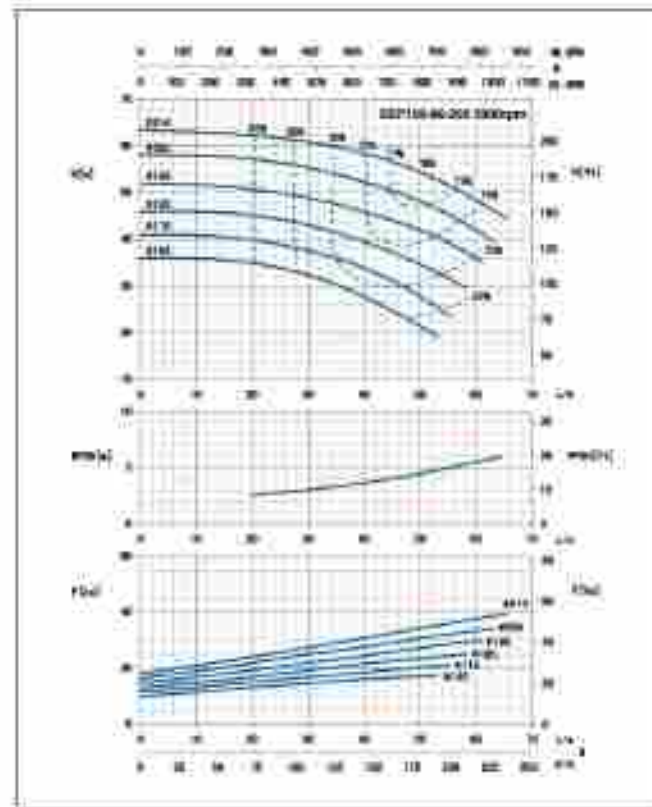
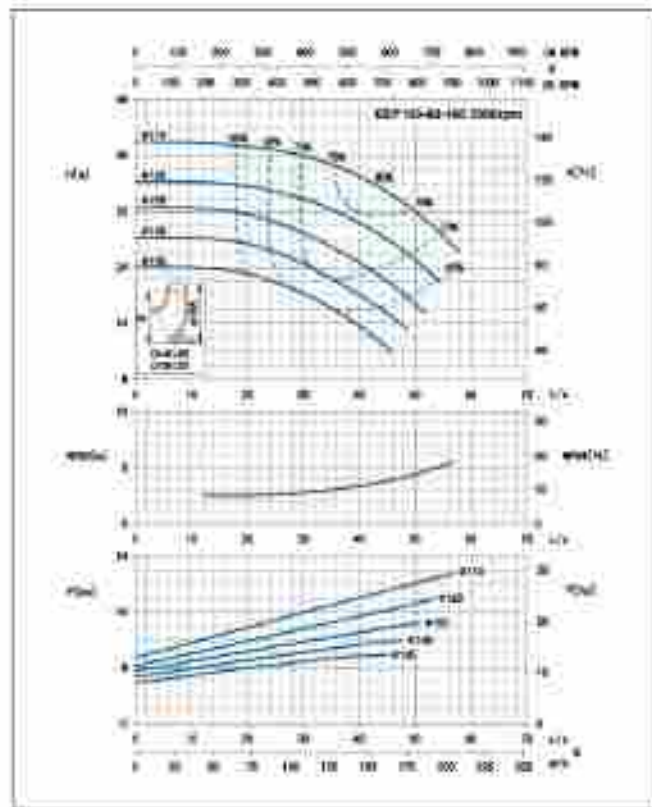

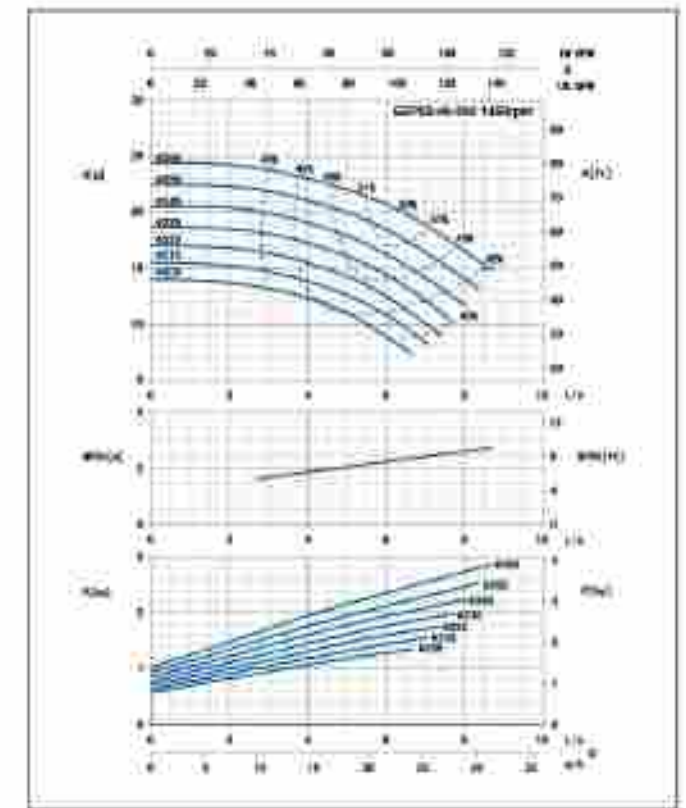
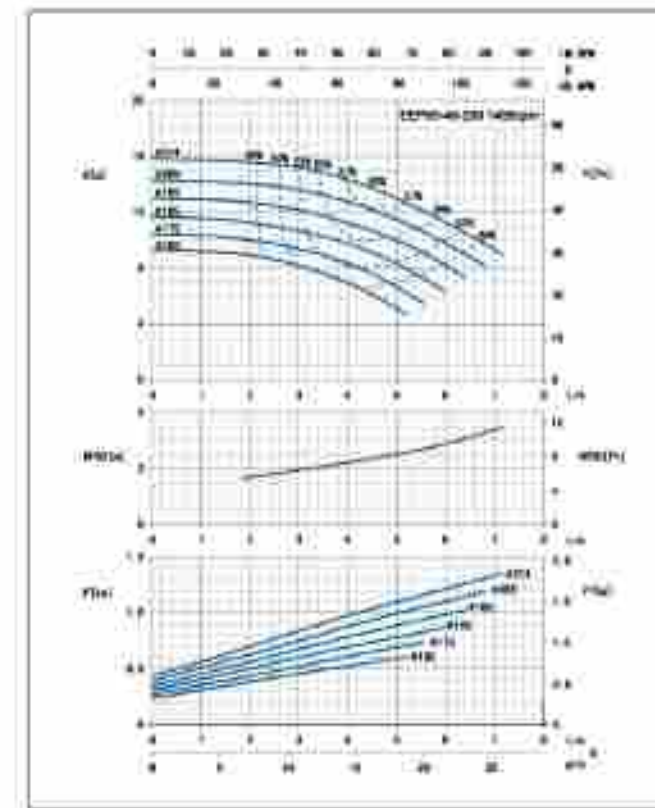
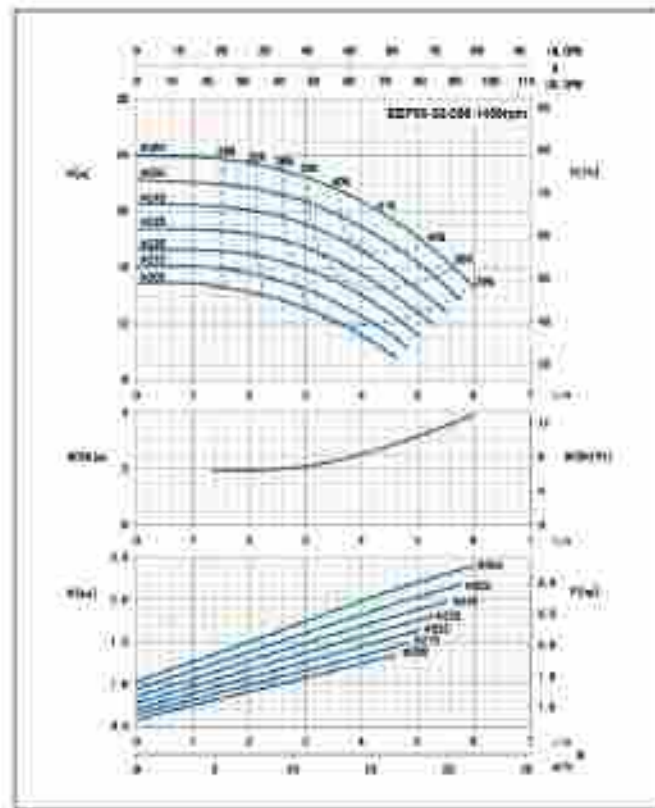
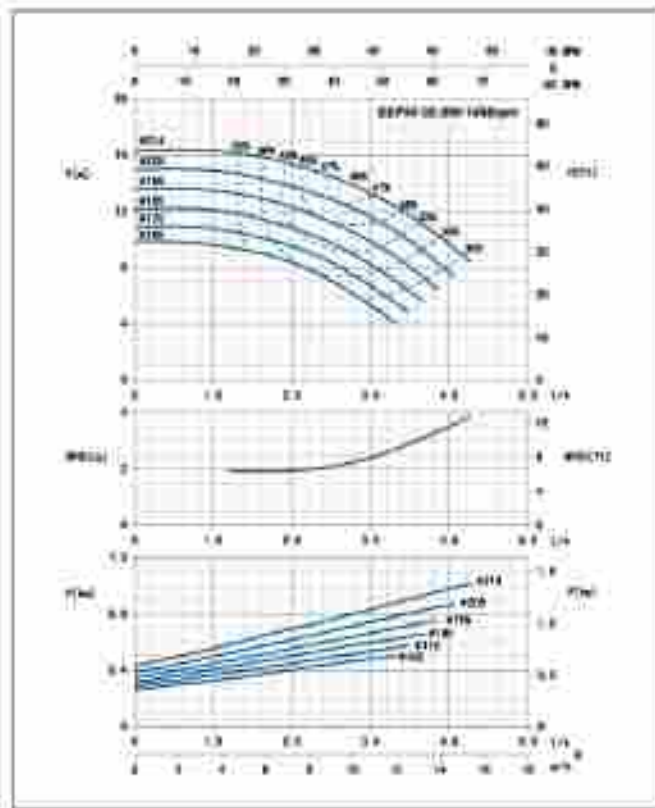
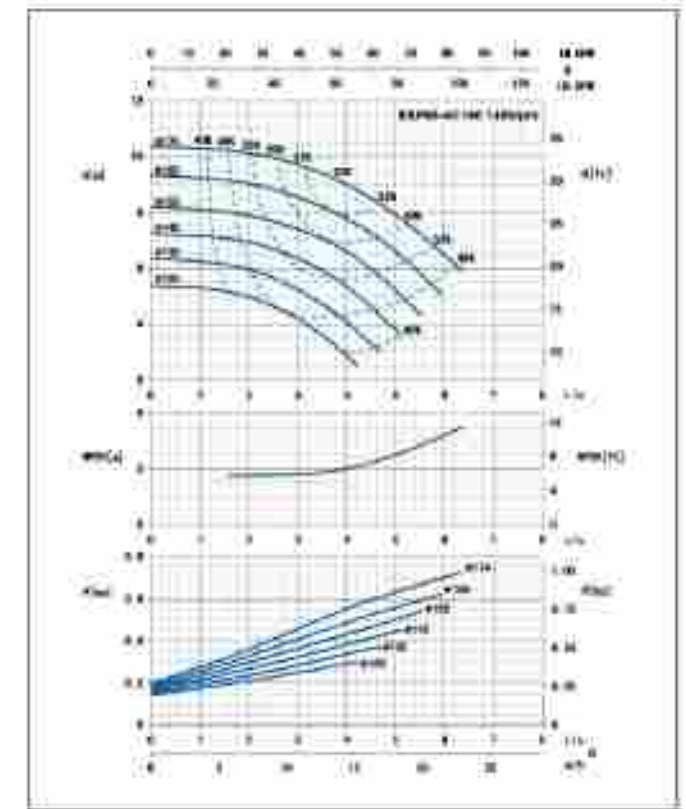
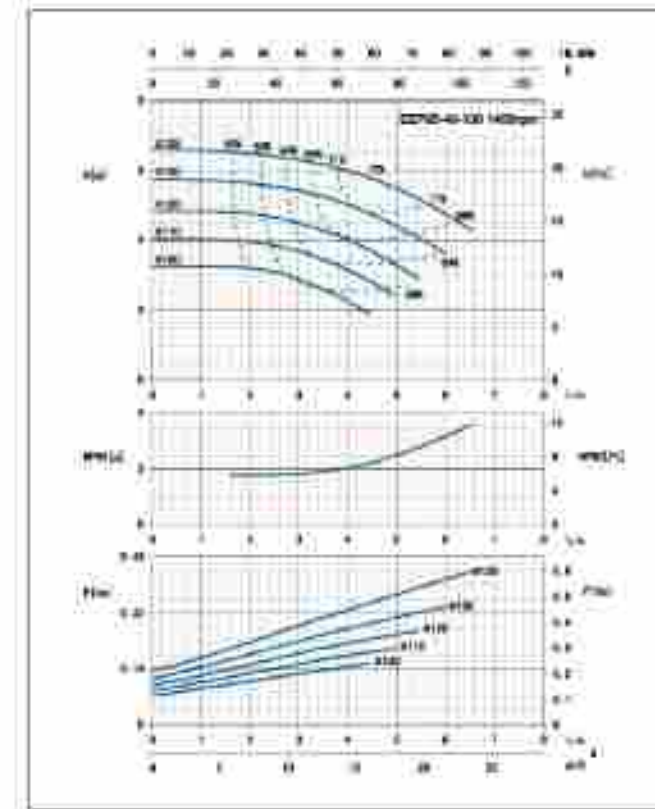
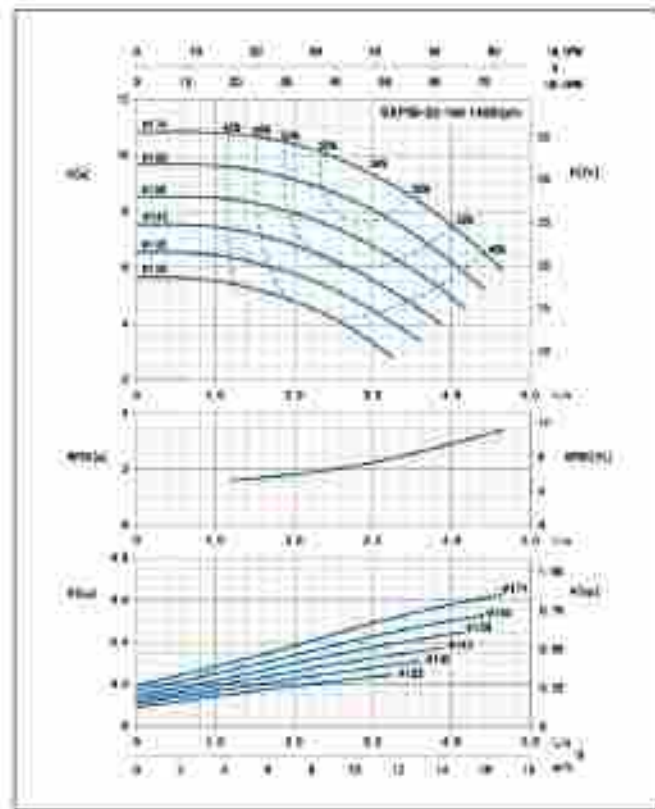
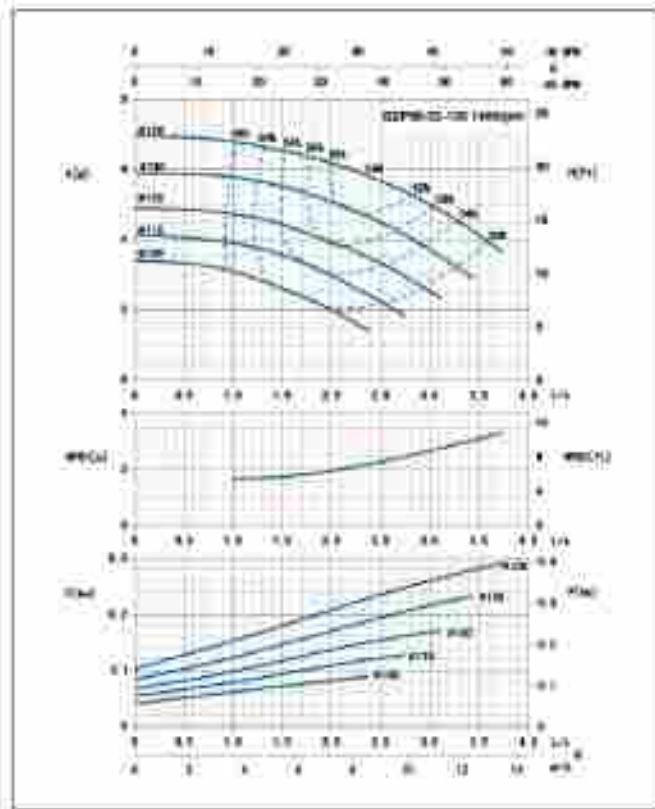

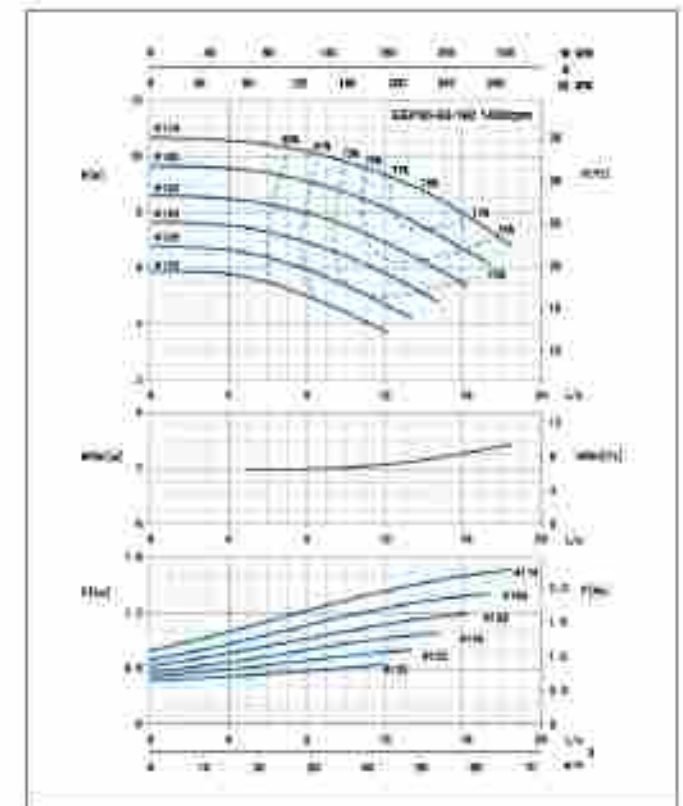
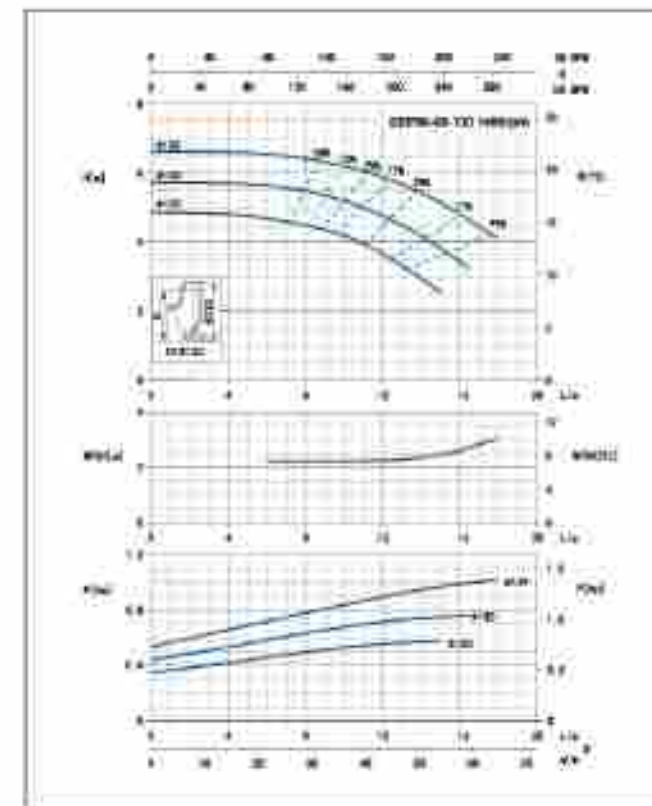
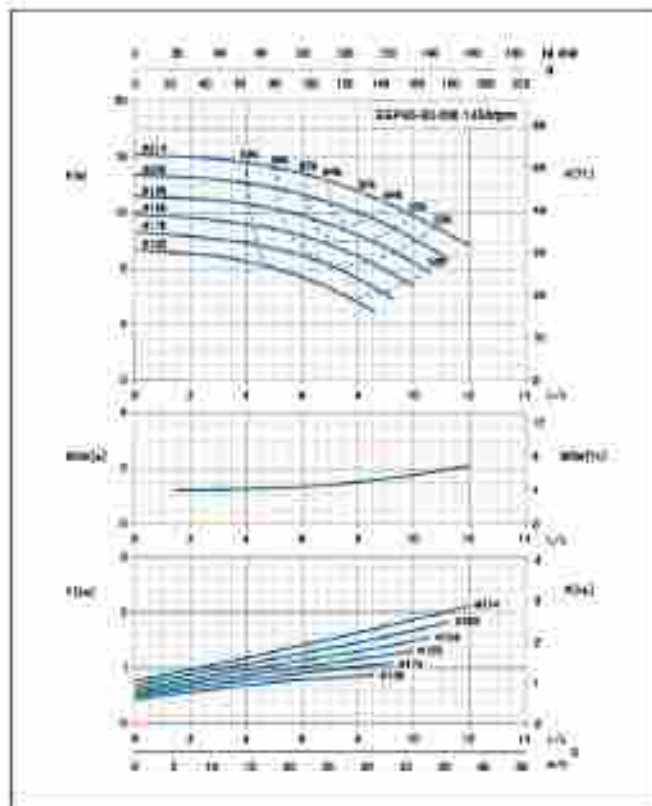
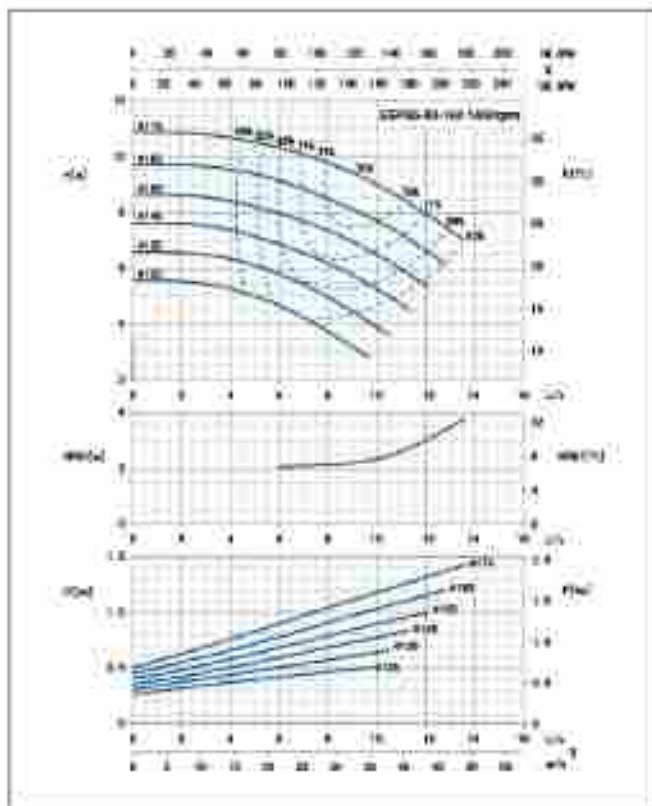
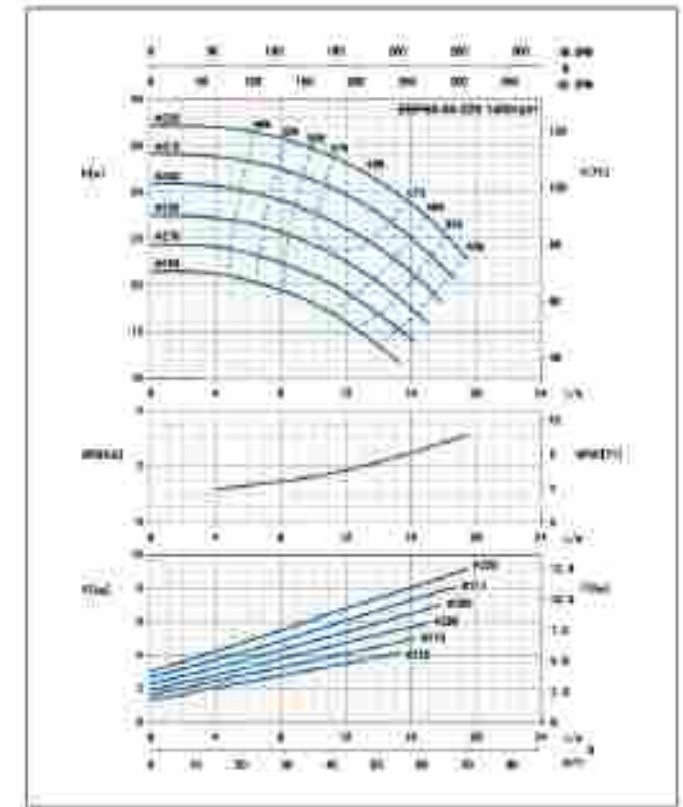
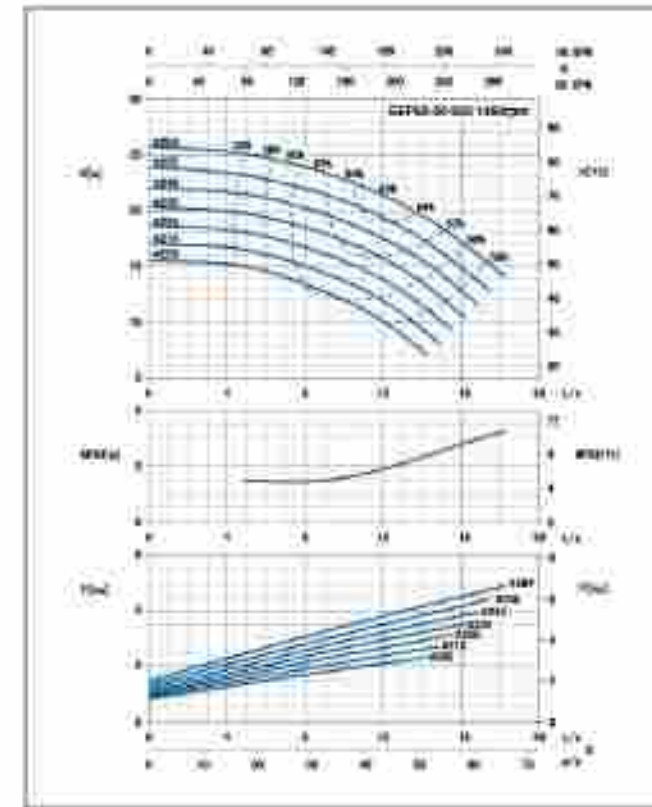
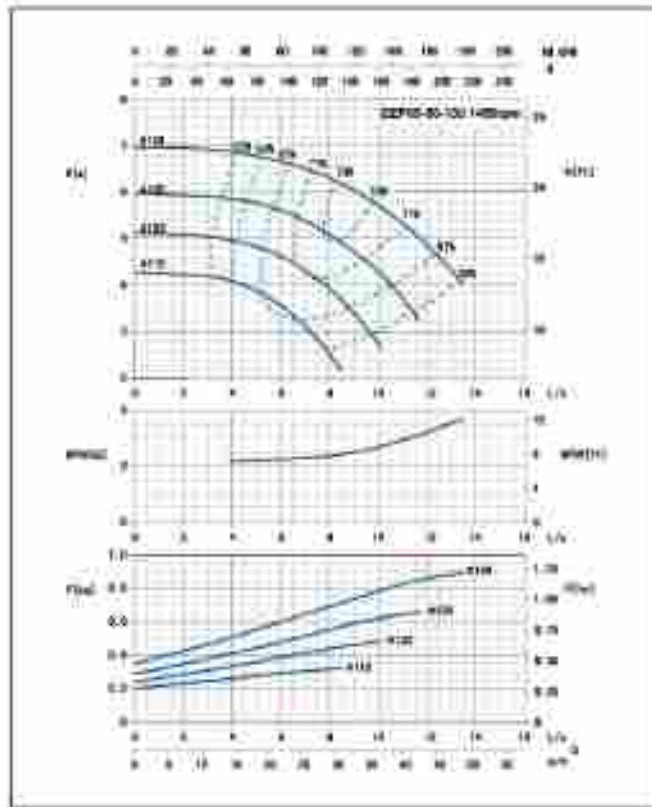
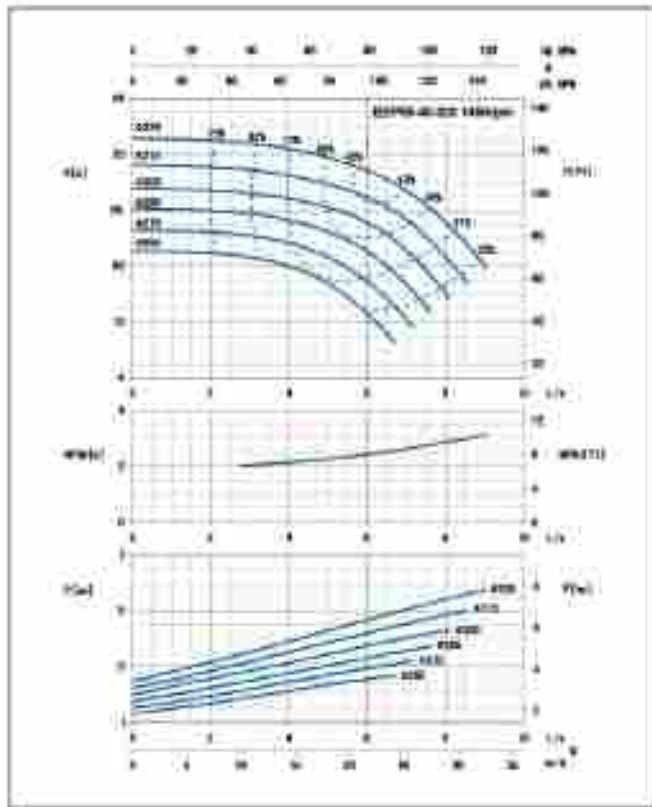

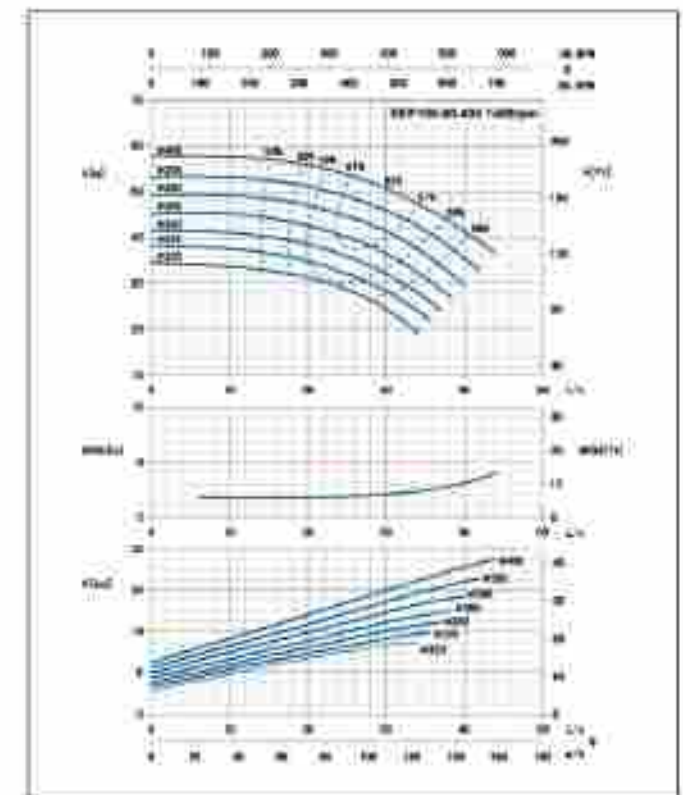
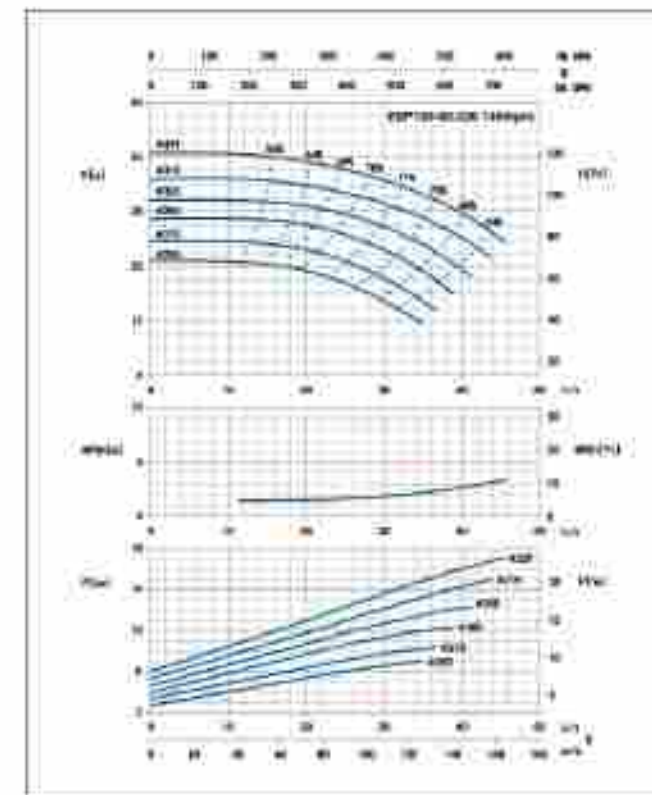
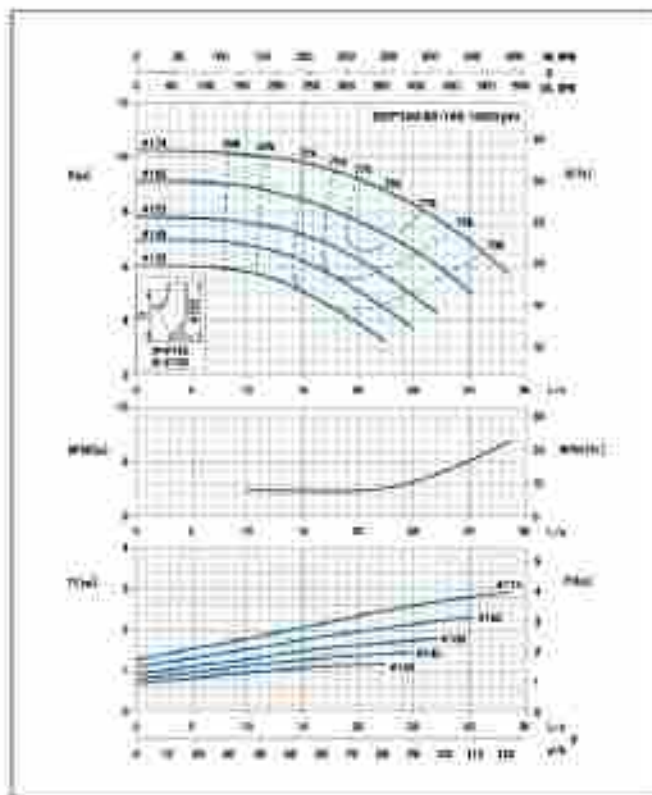
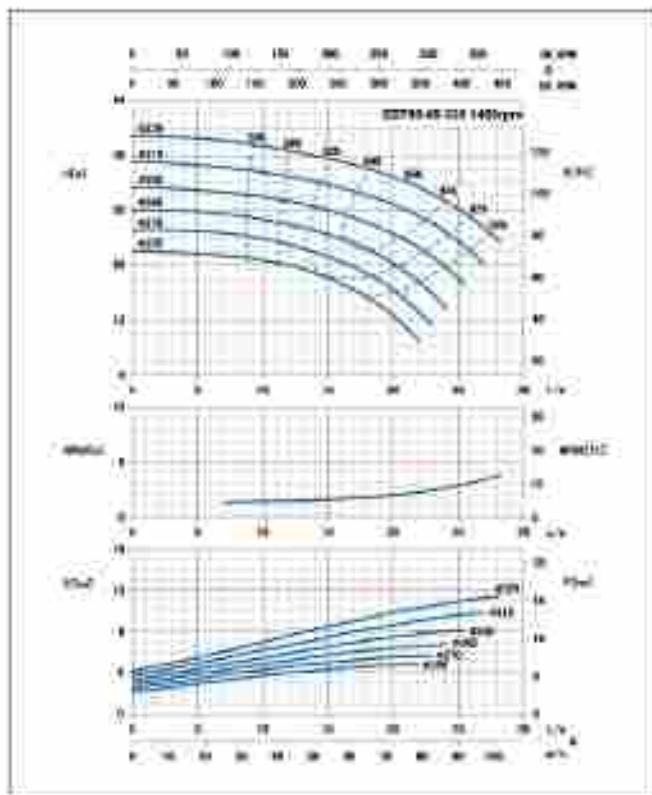
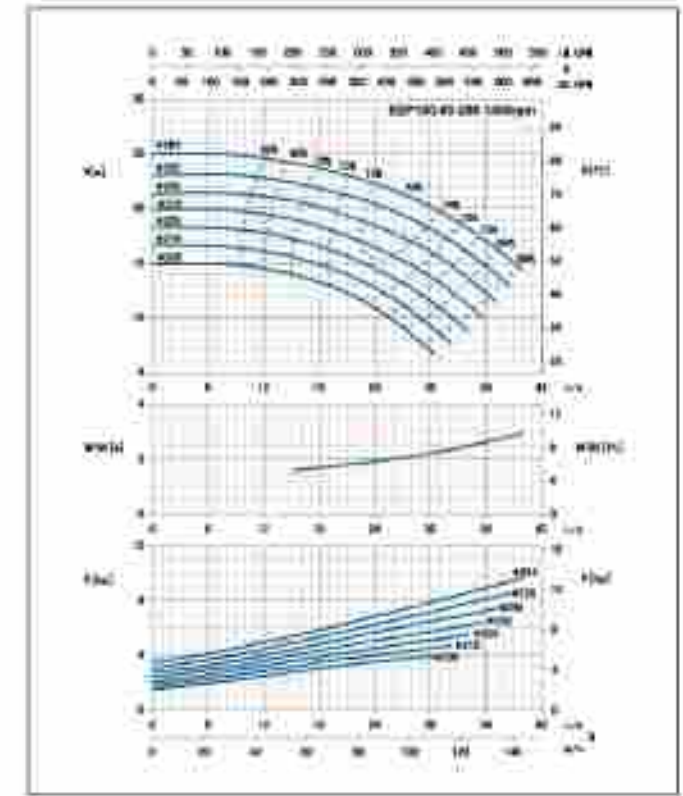
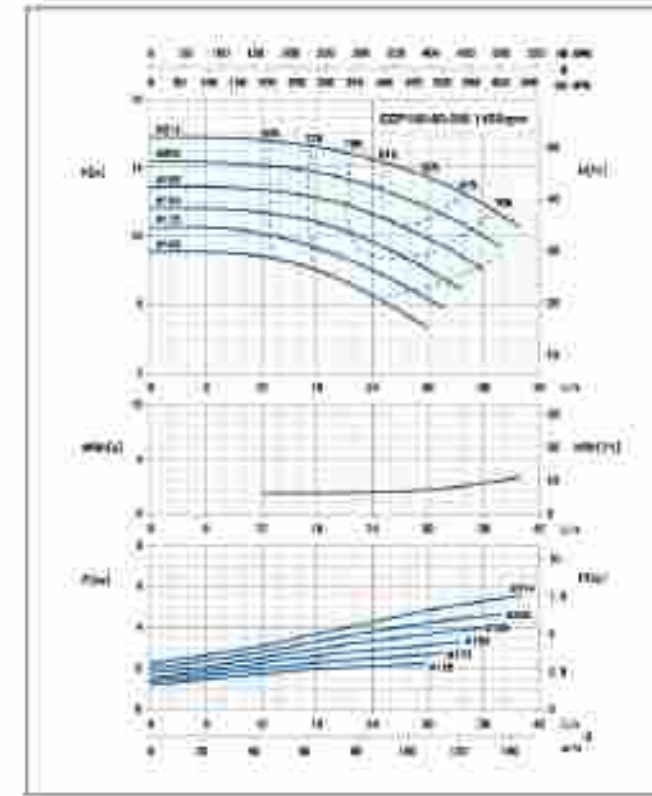
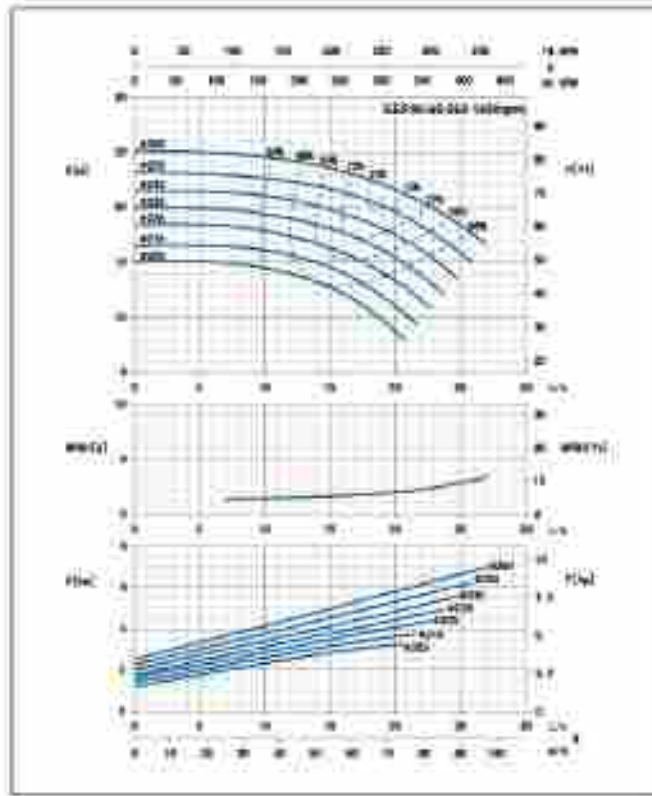
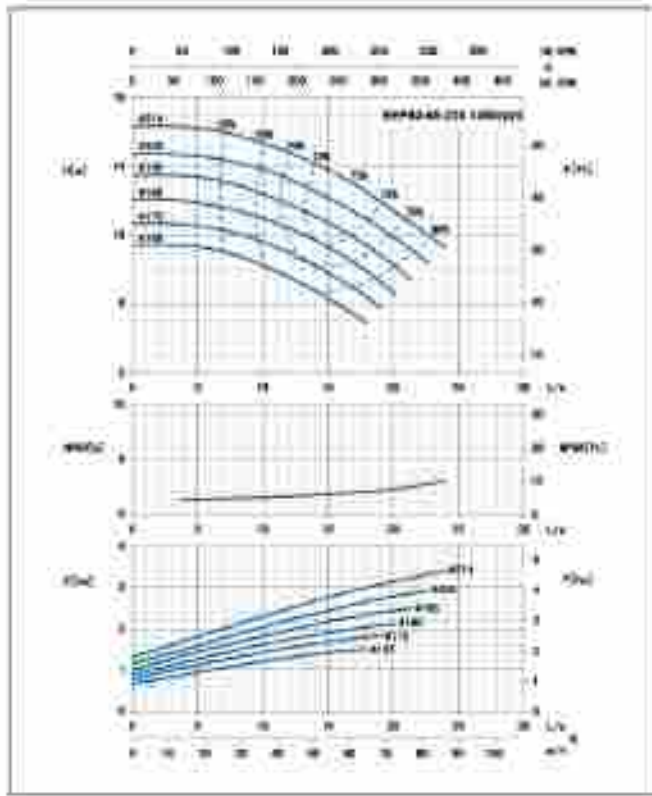

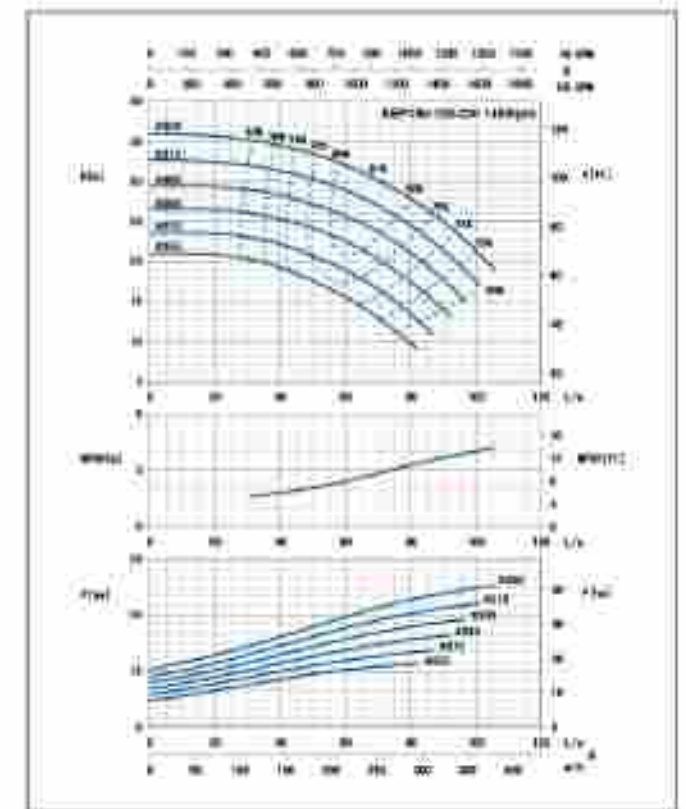
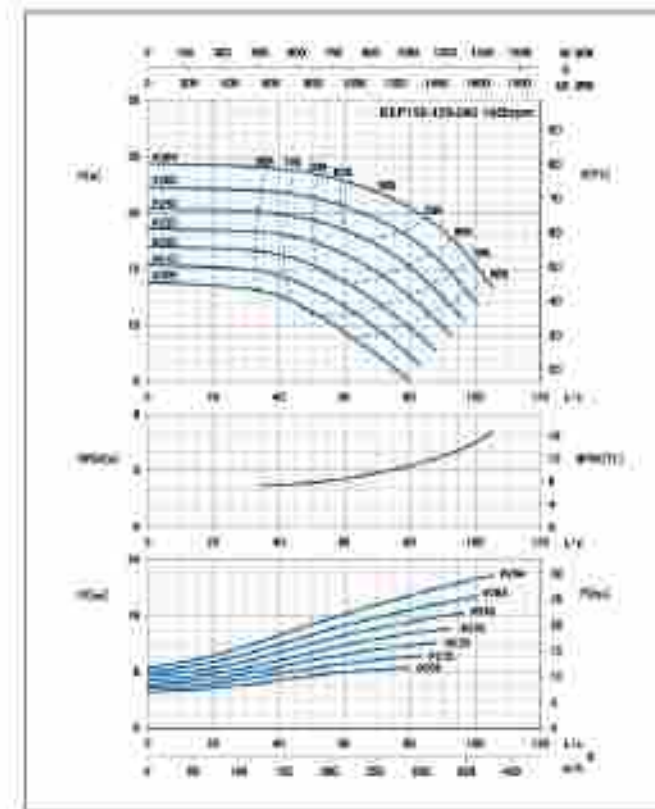
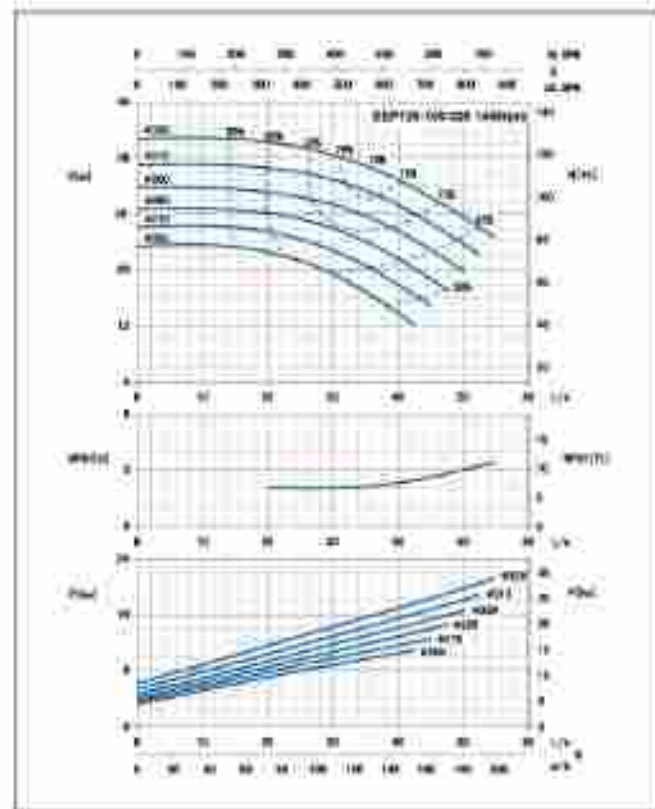
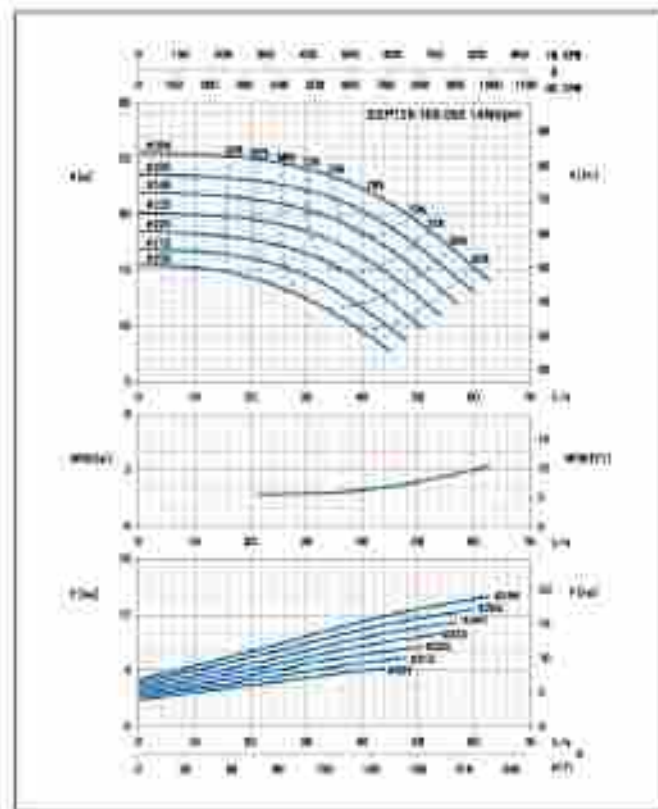
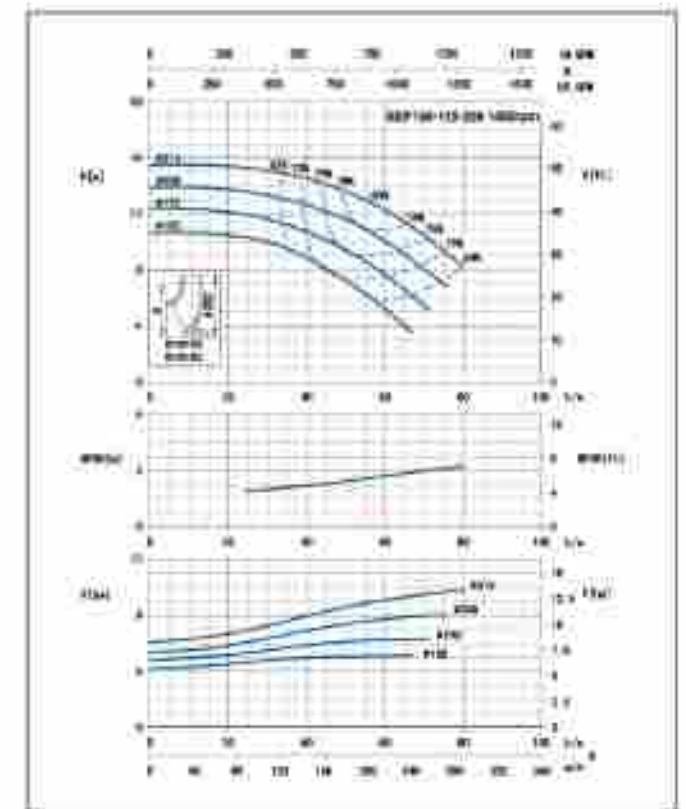
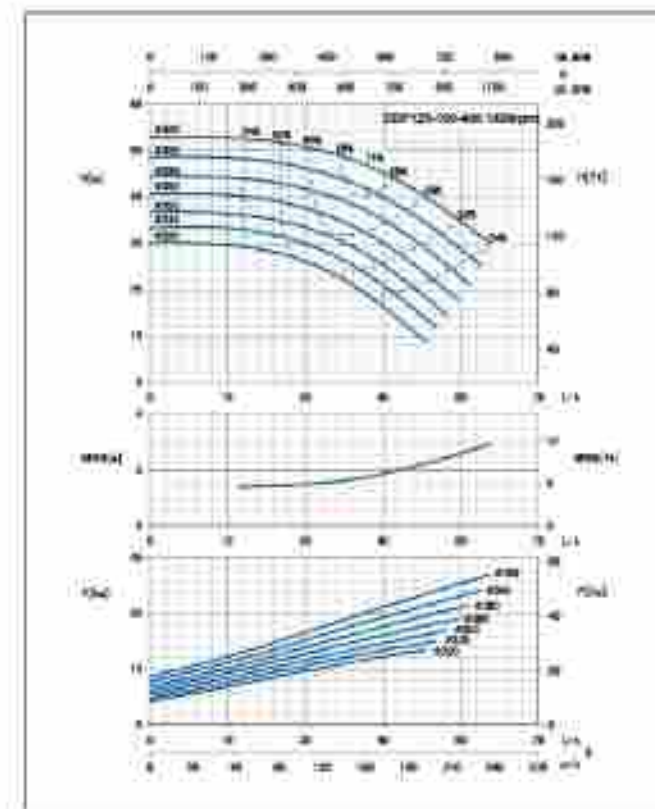
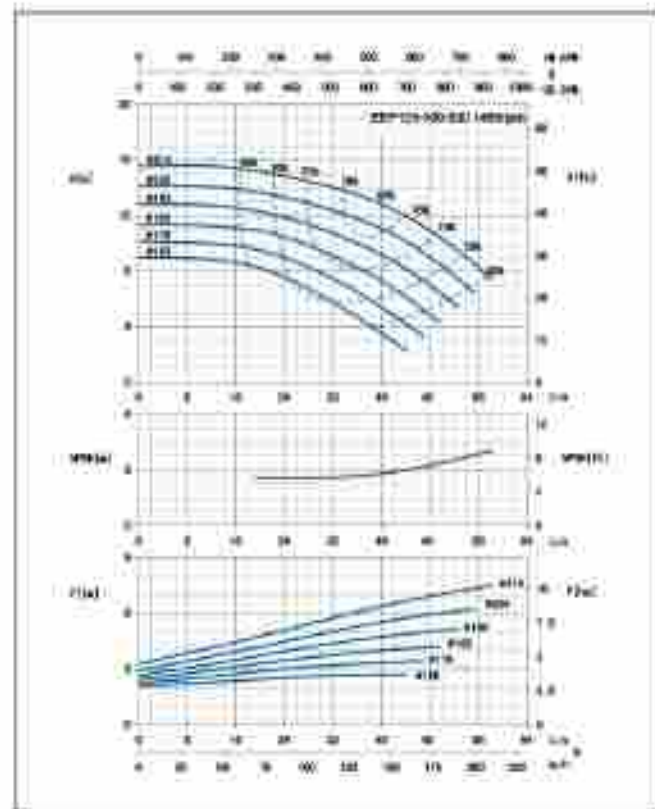
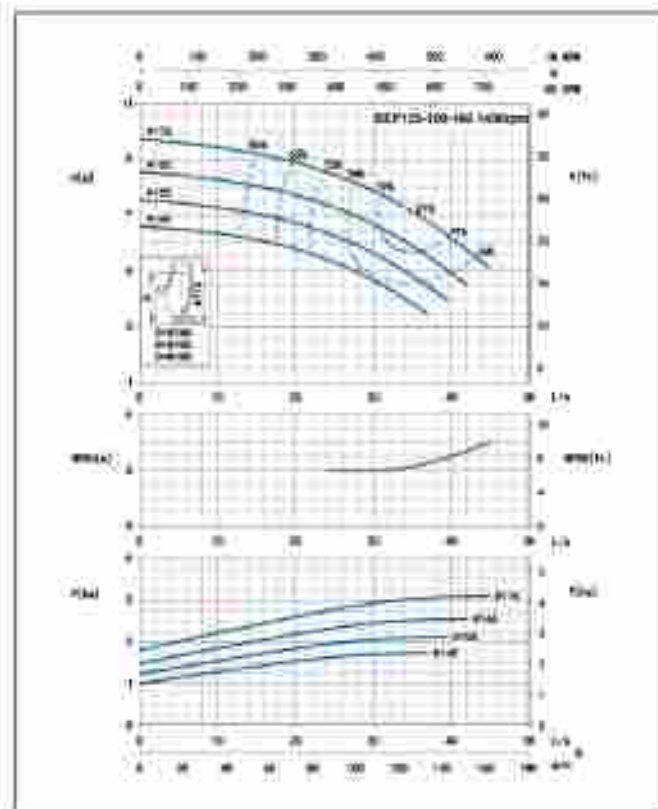

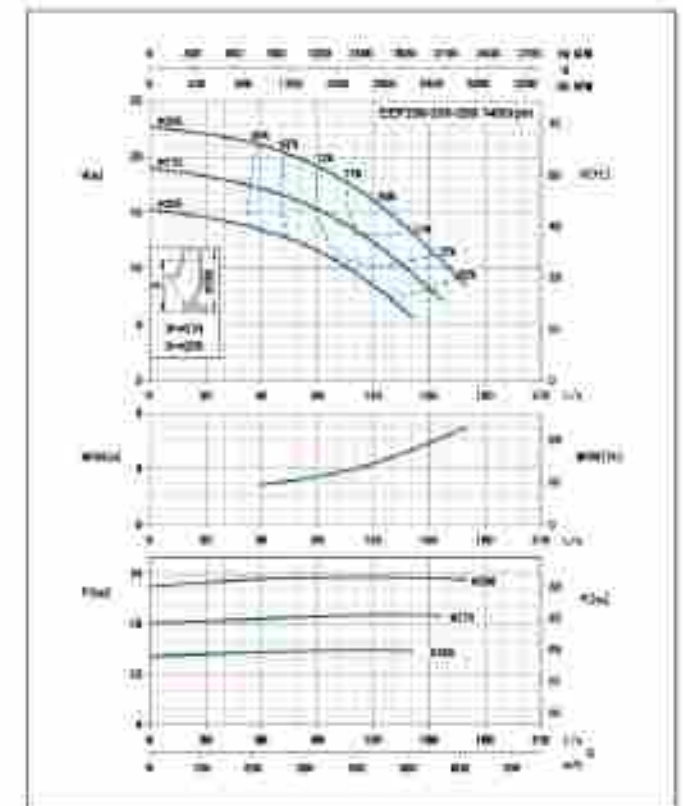
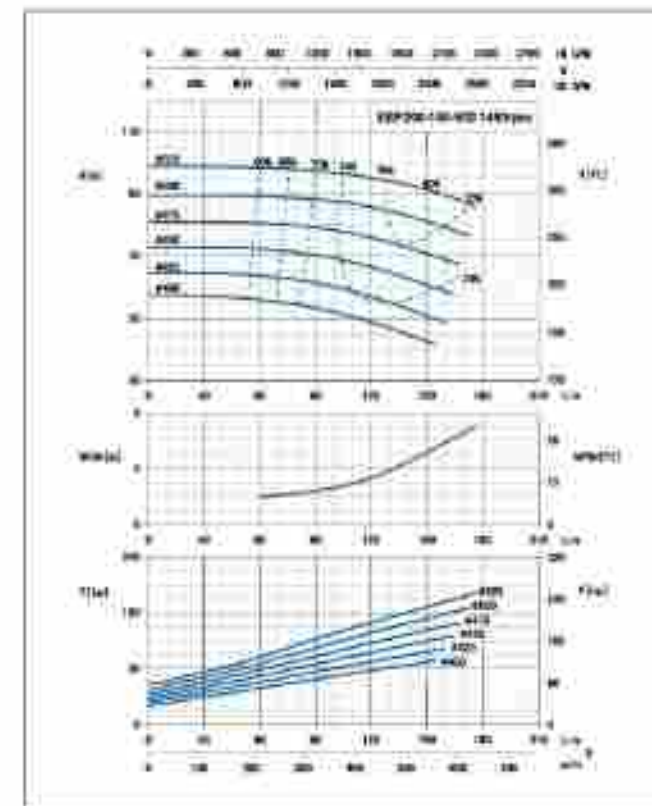
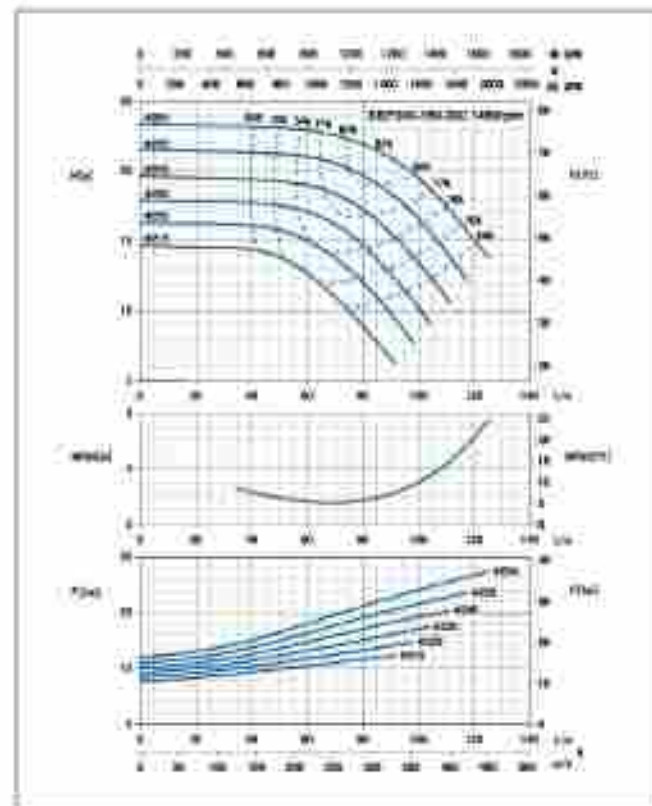
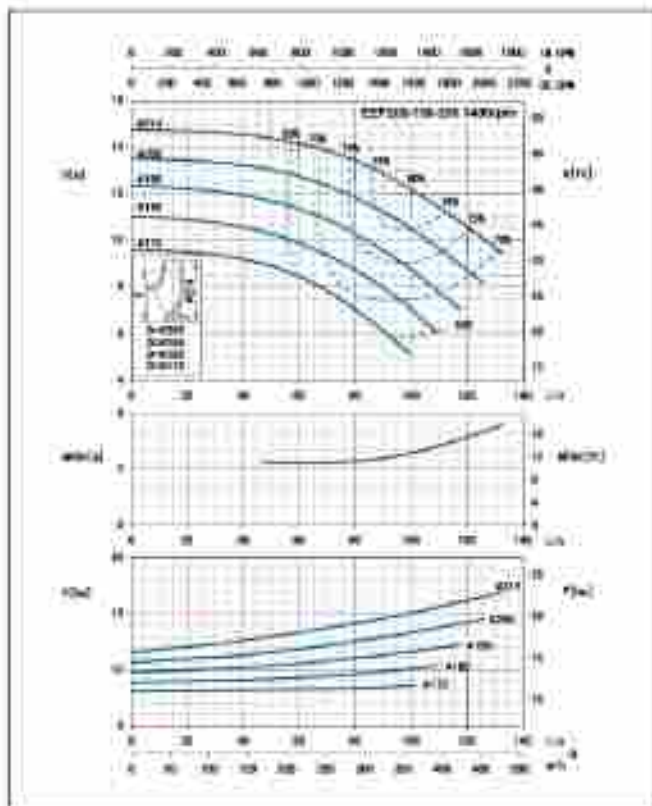
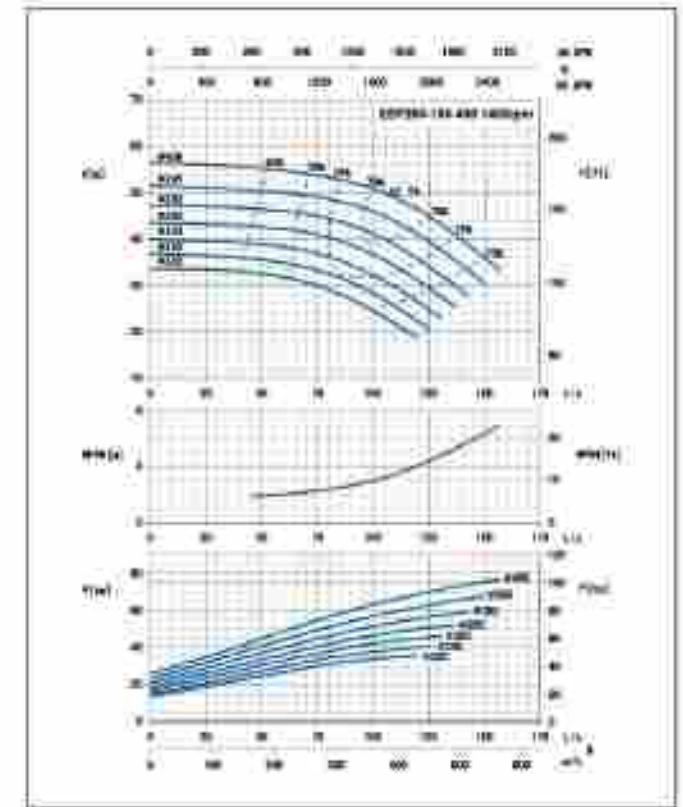
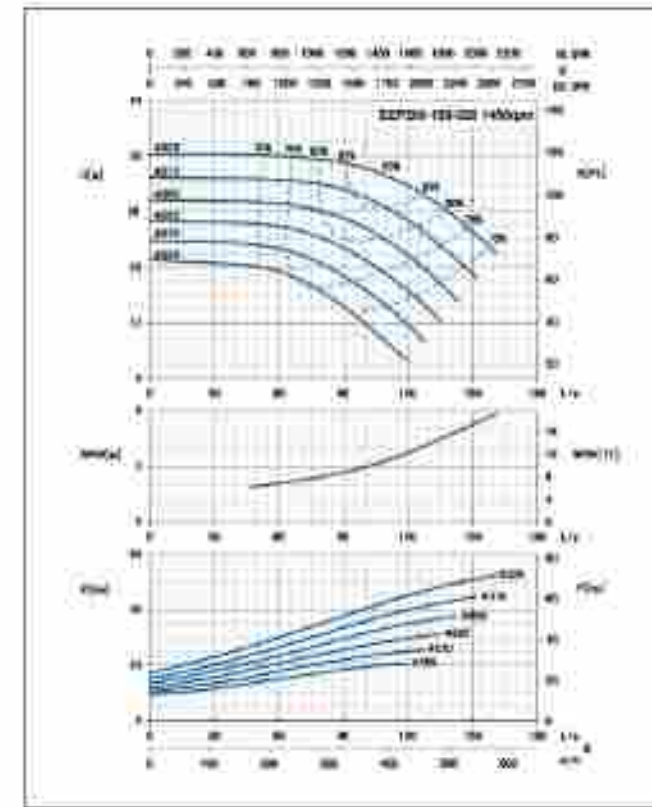
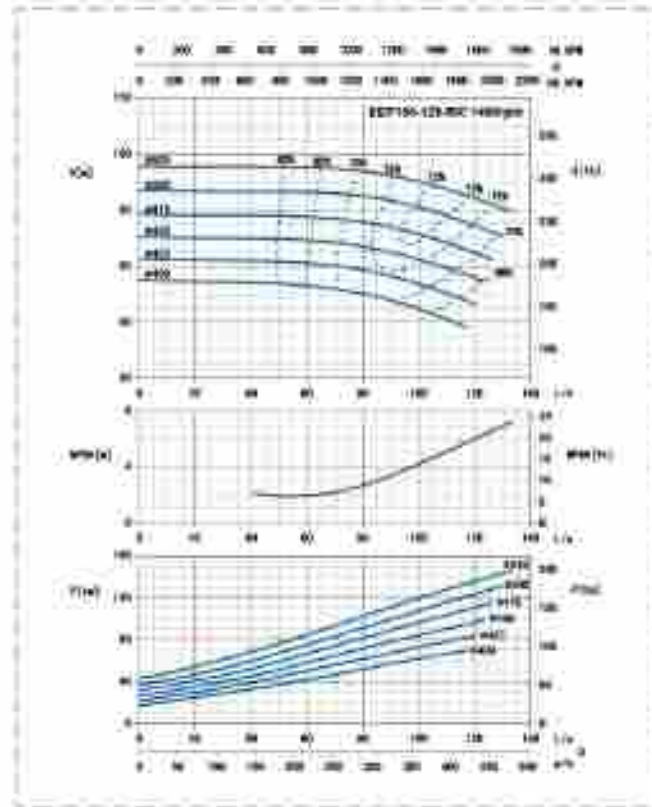
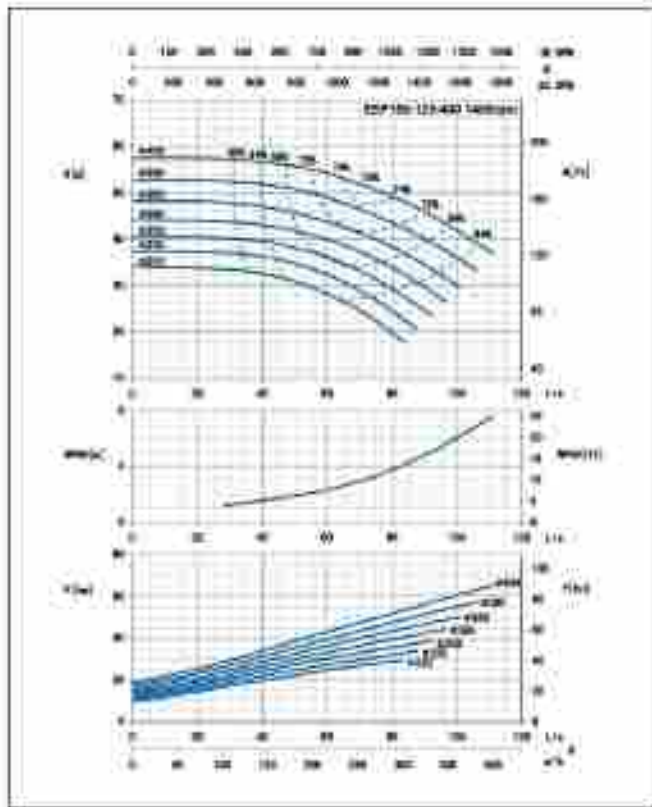

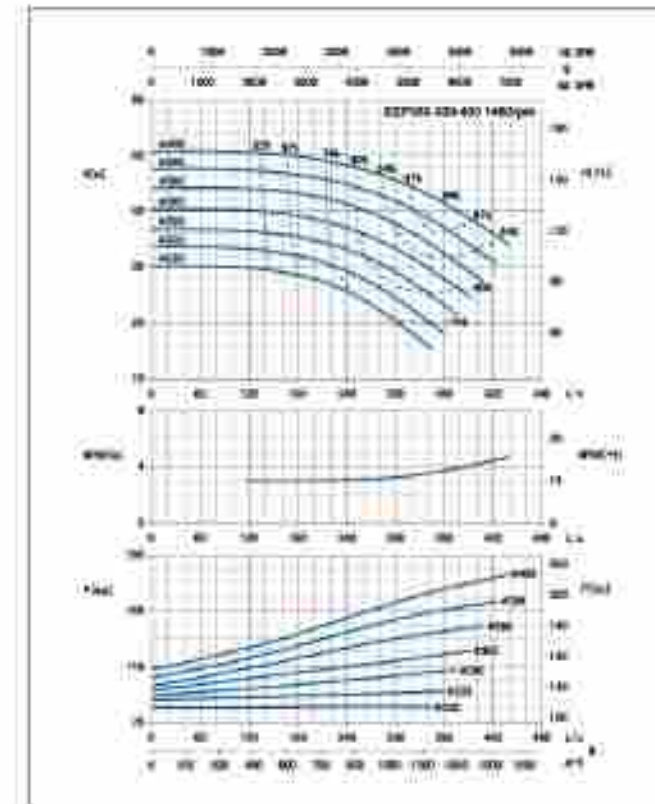
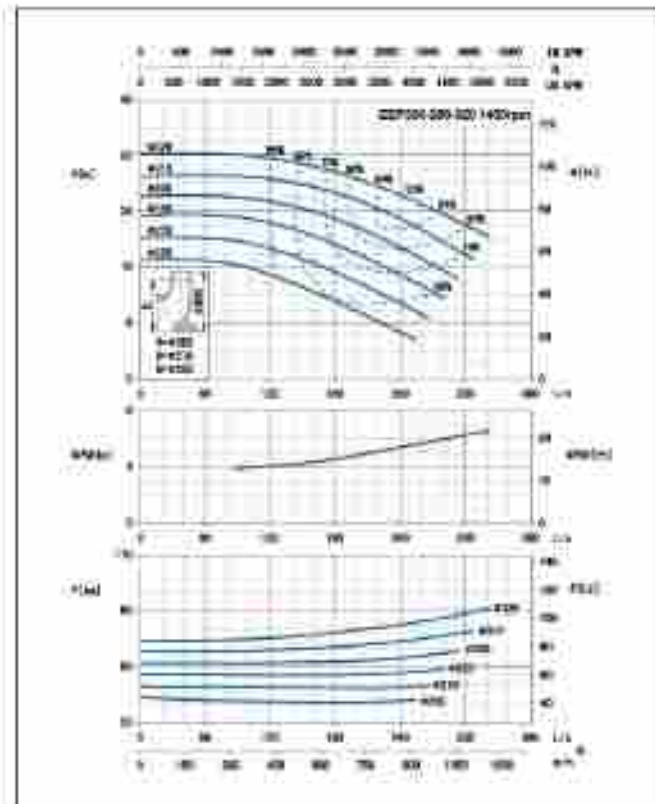
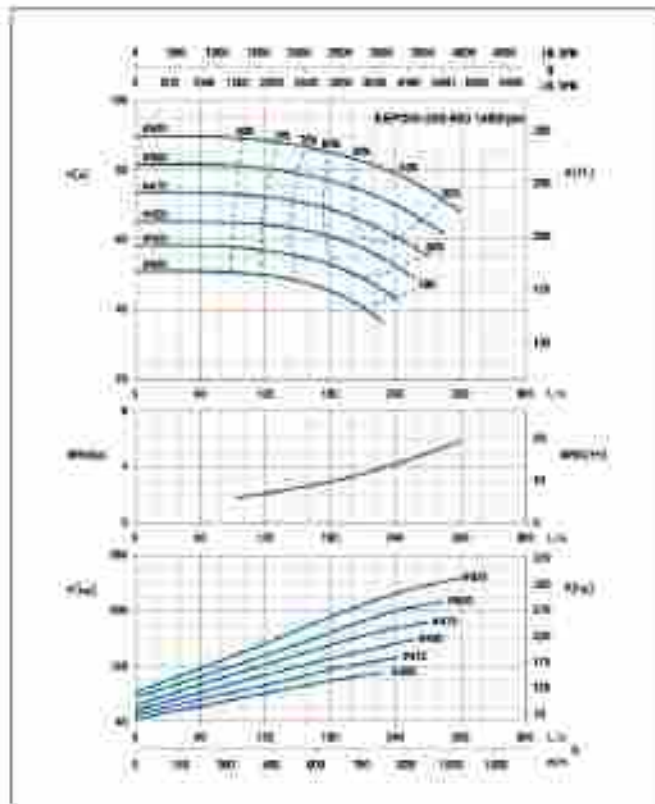
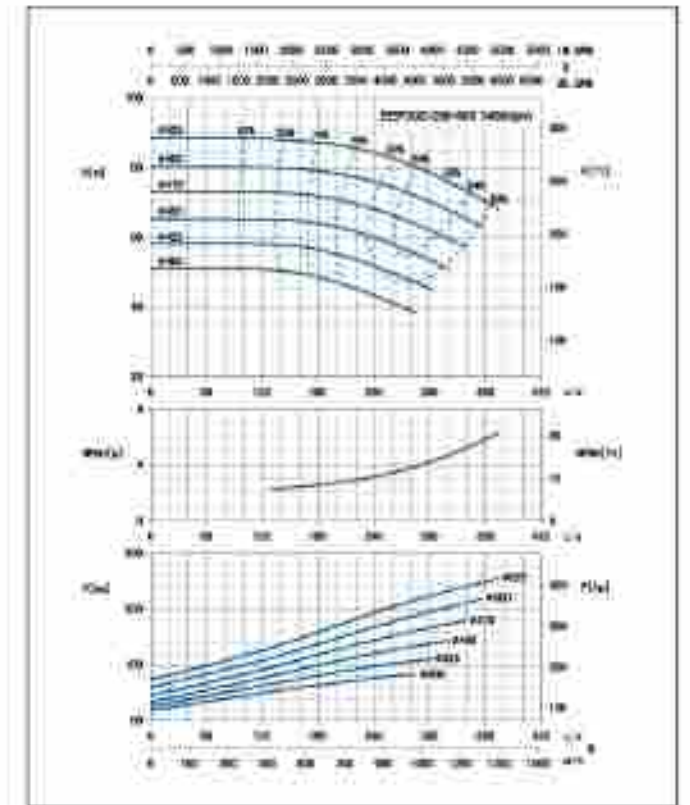
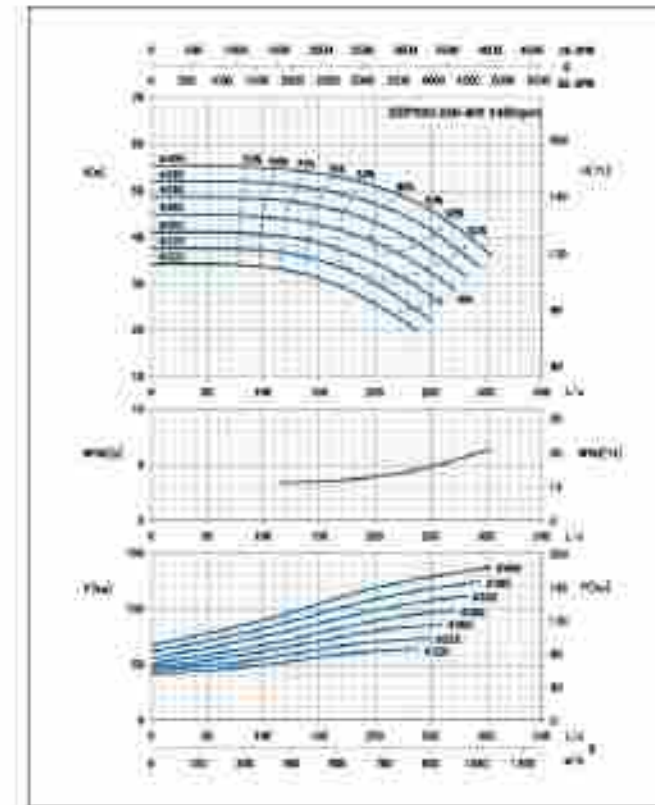
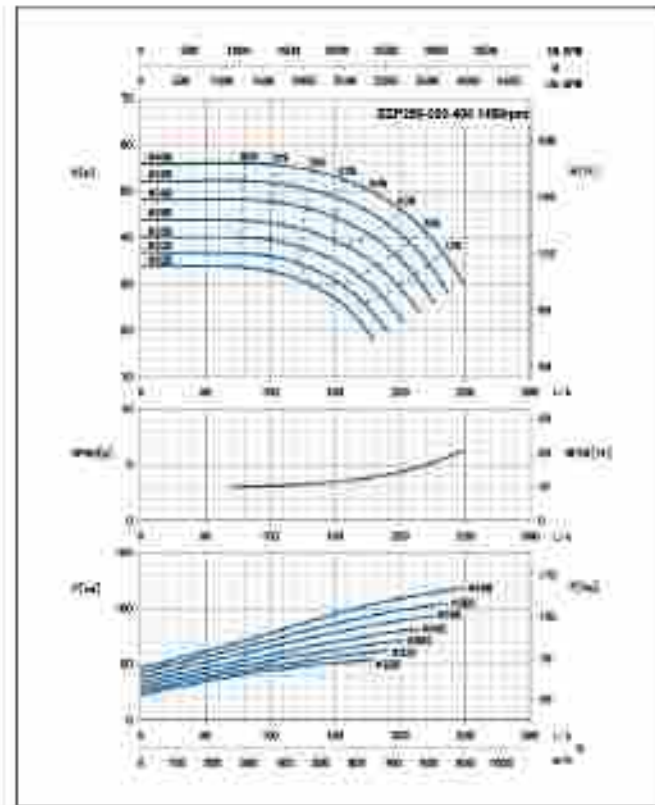
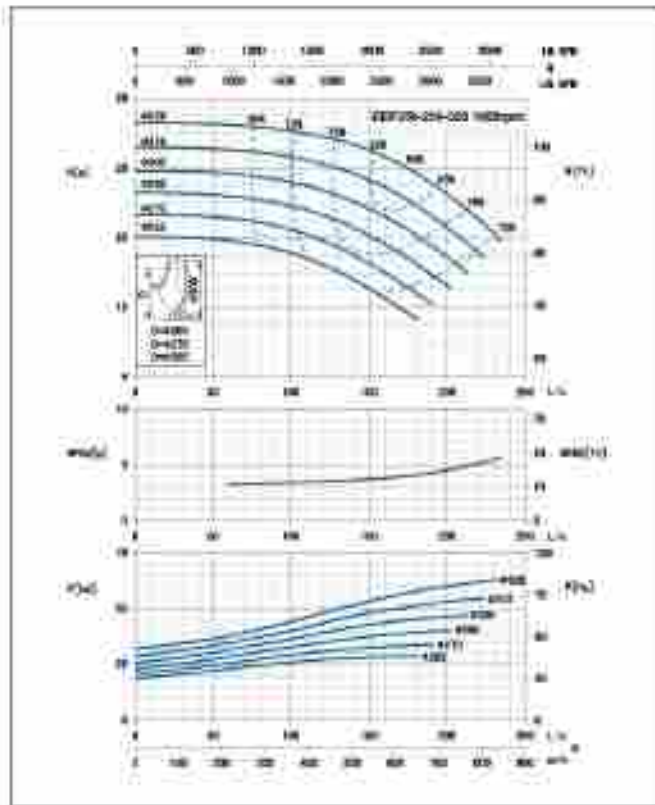

End Suction Centrifugal Pump

End Suction Centrifugal Pump

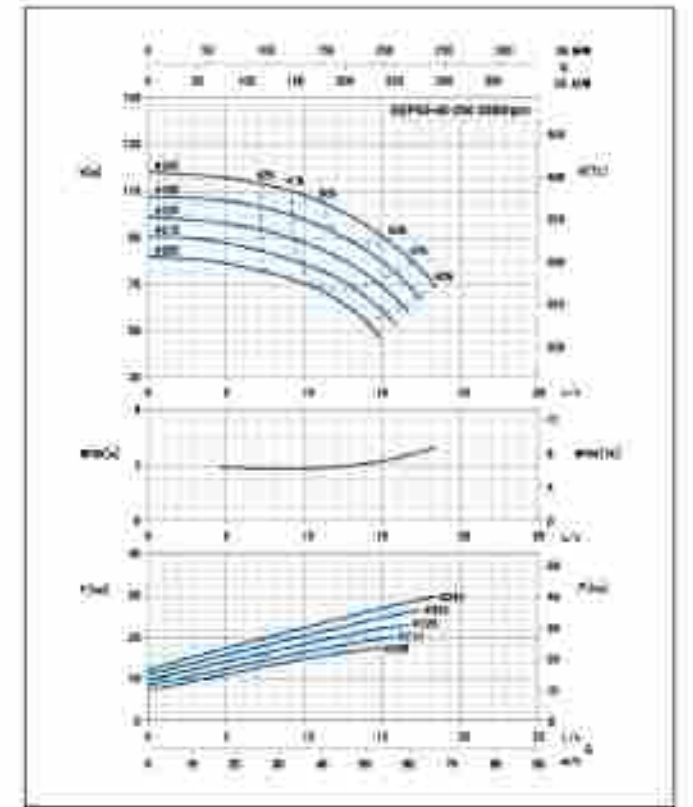
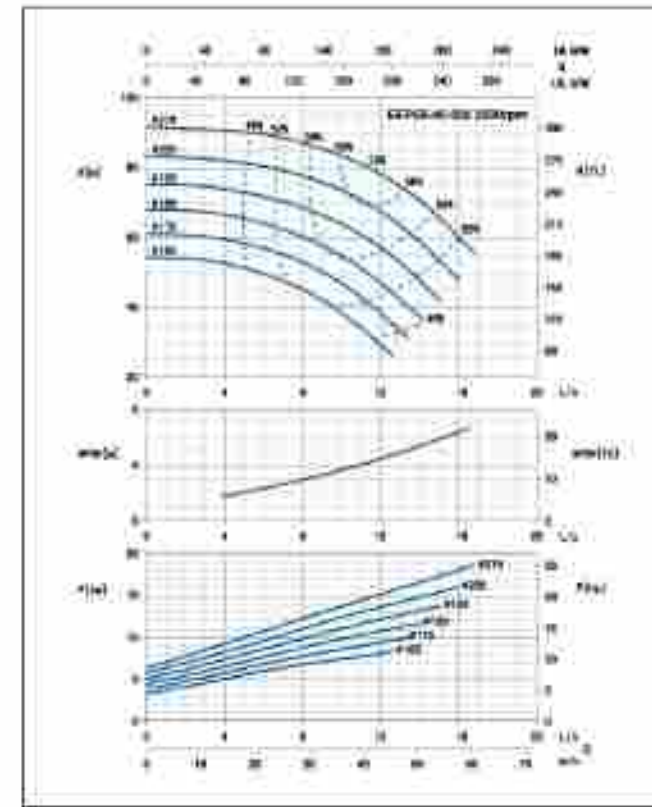
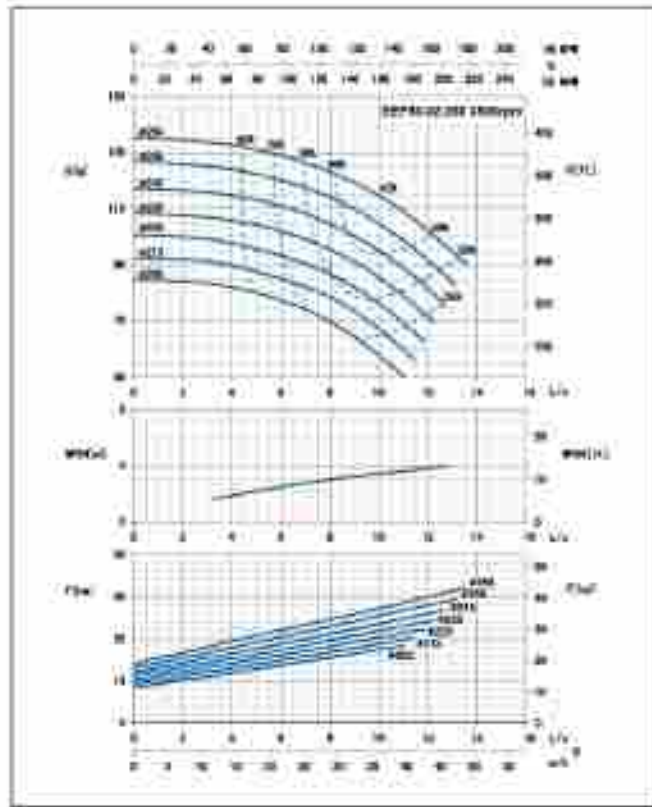
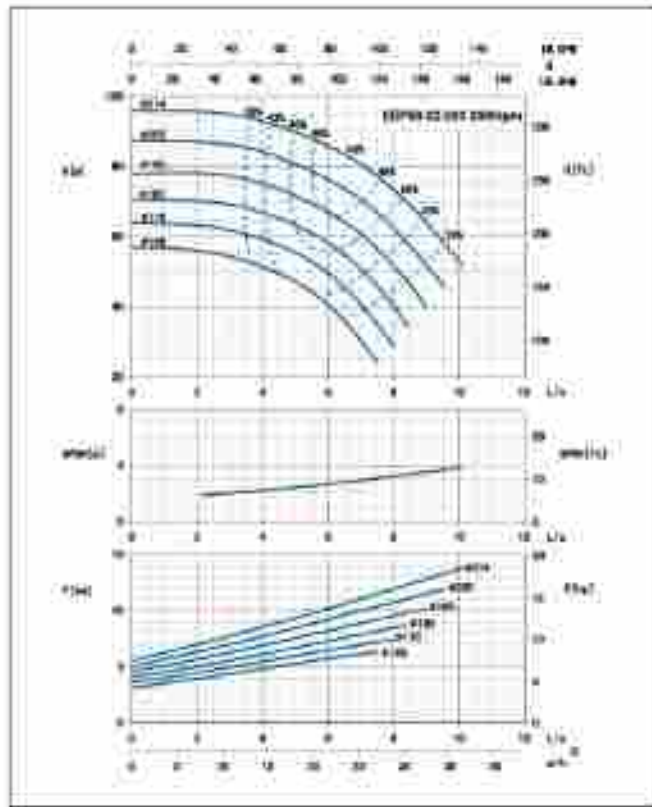
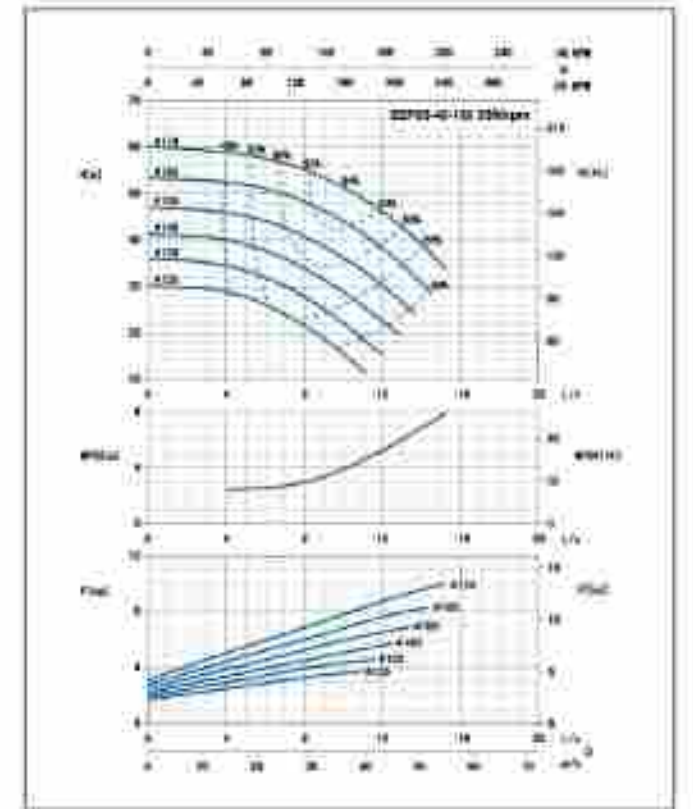
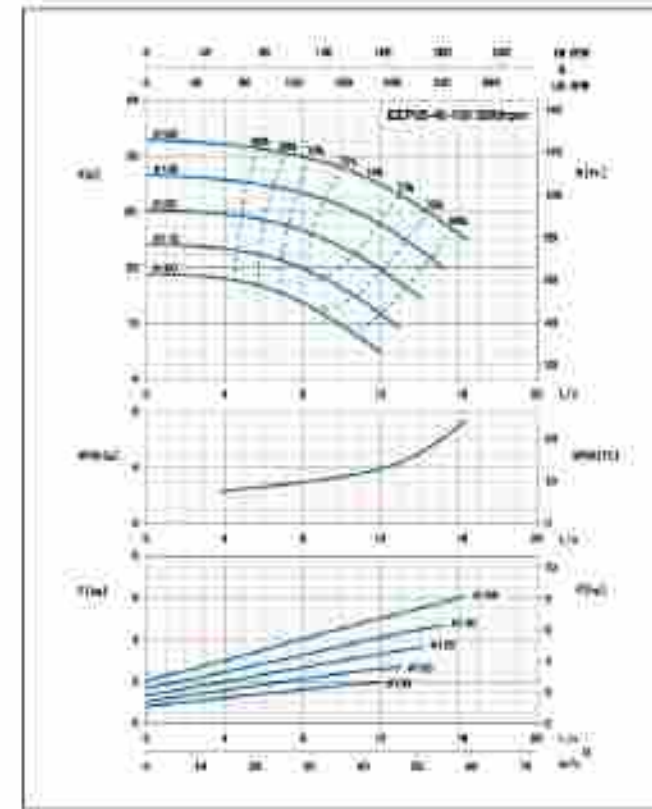
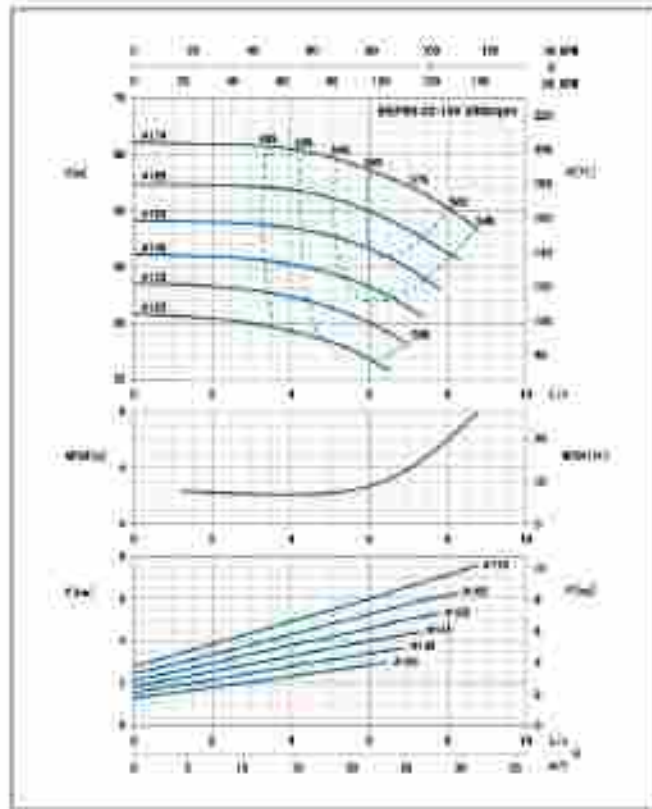
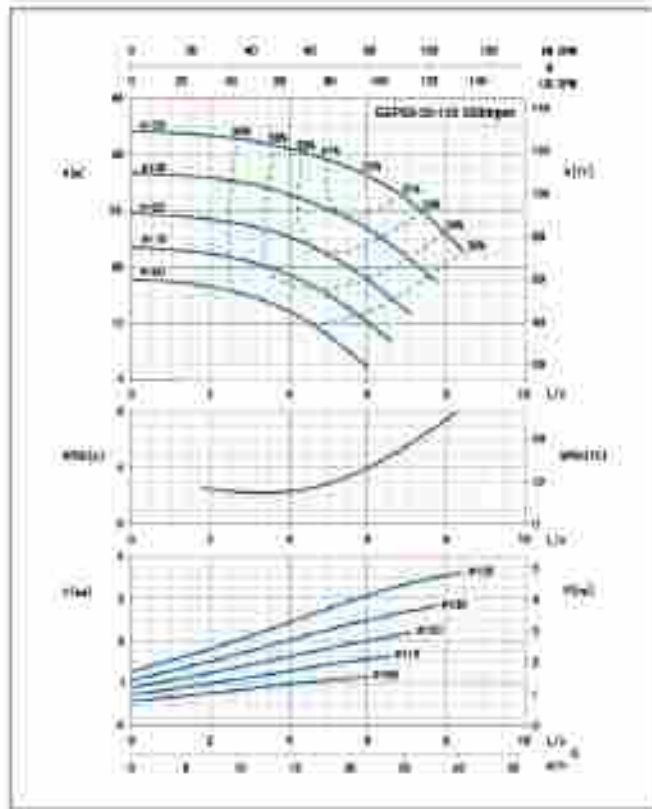

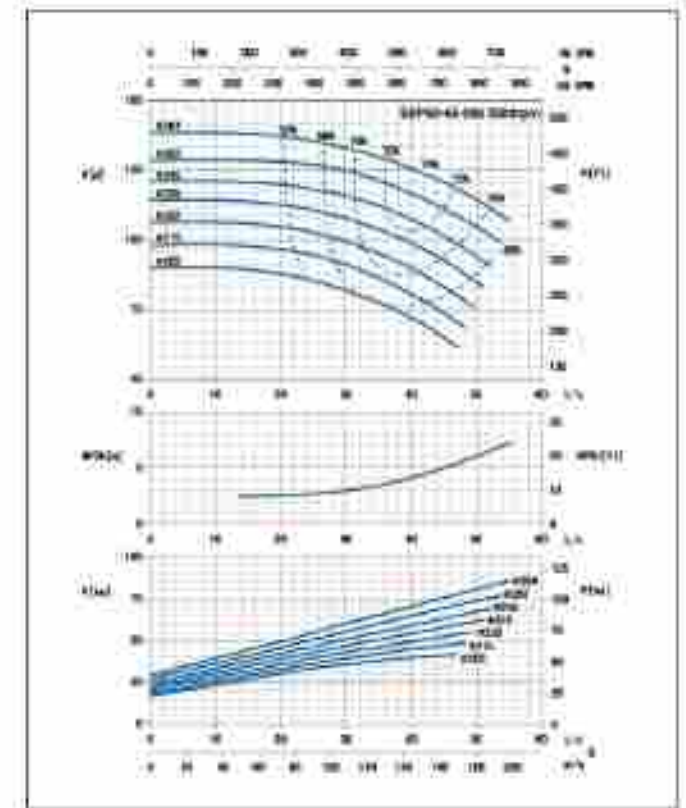
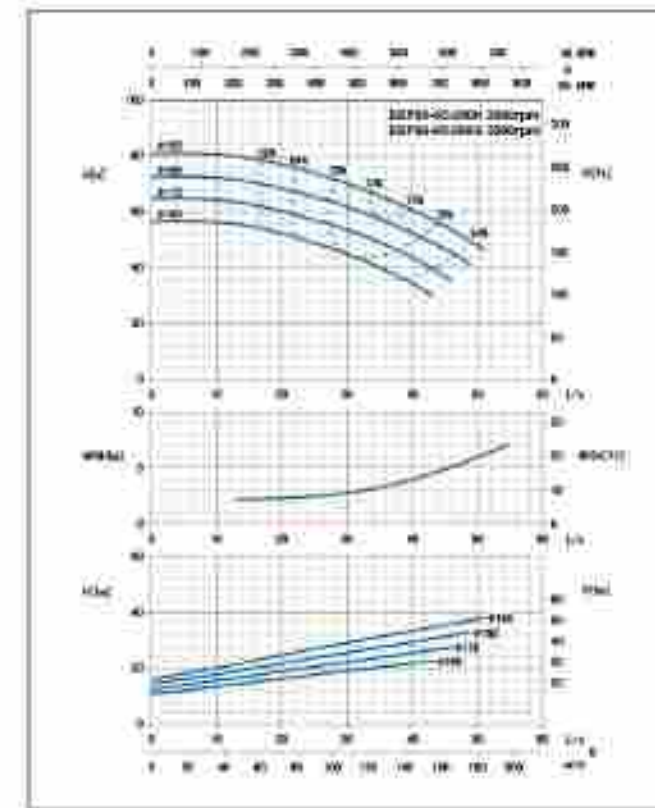
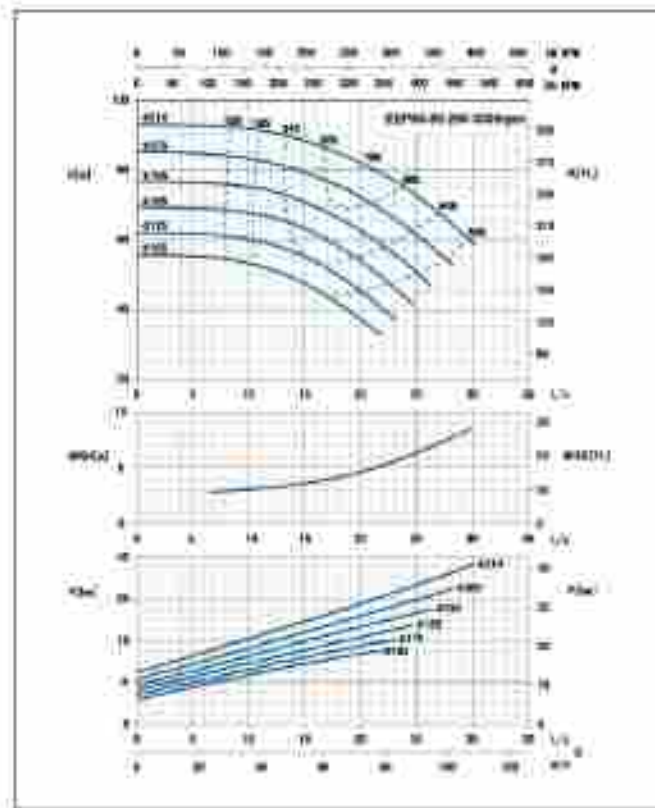
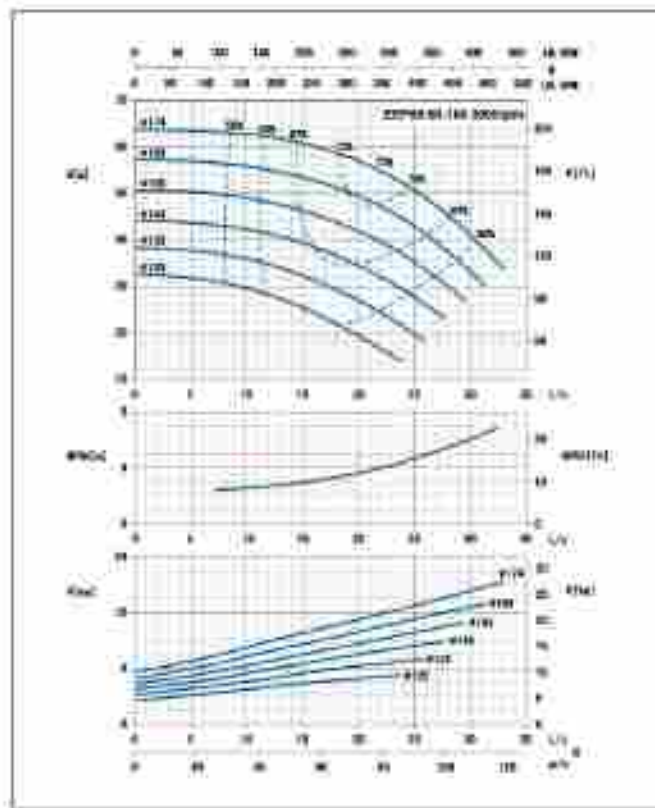
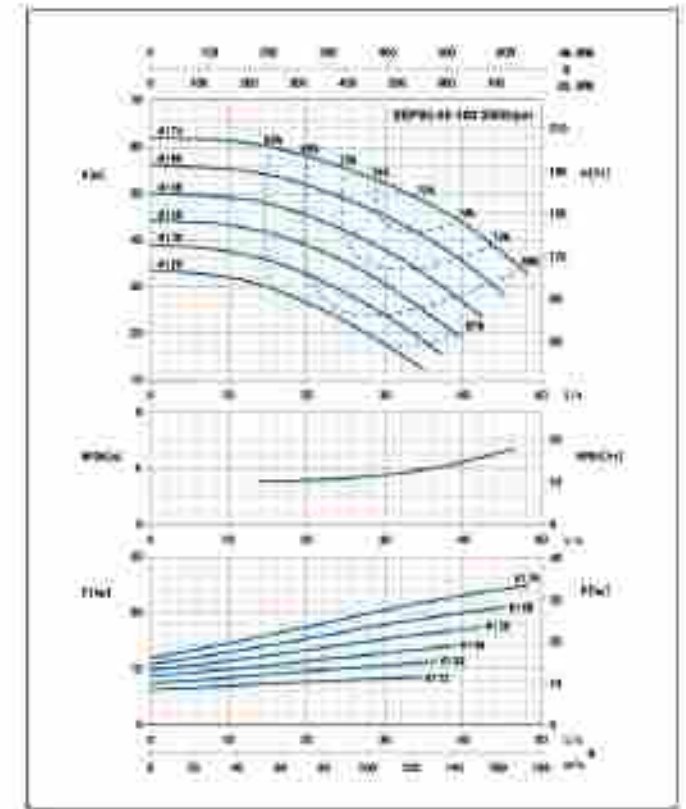
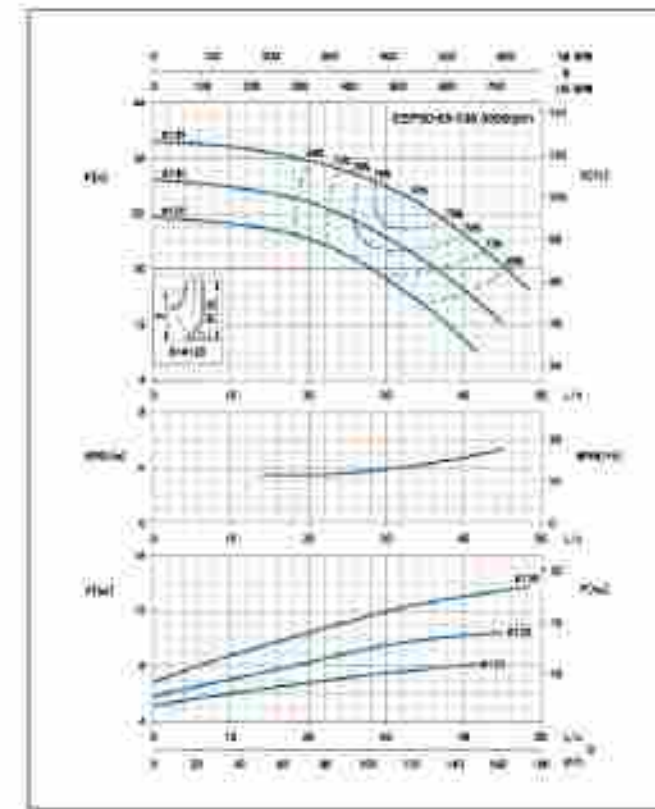
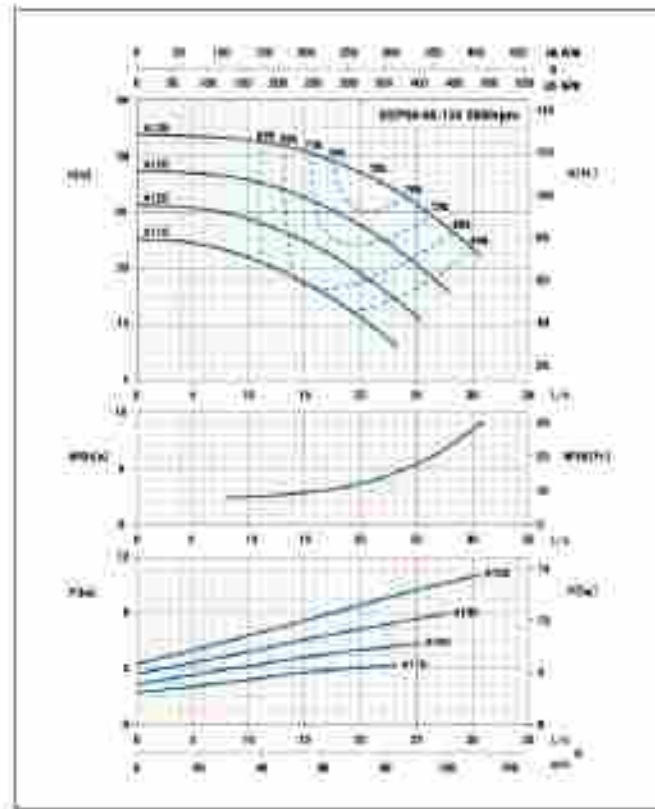
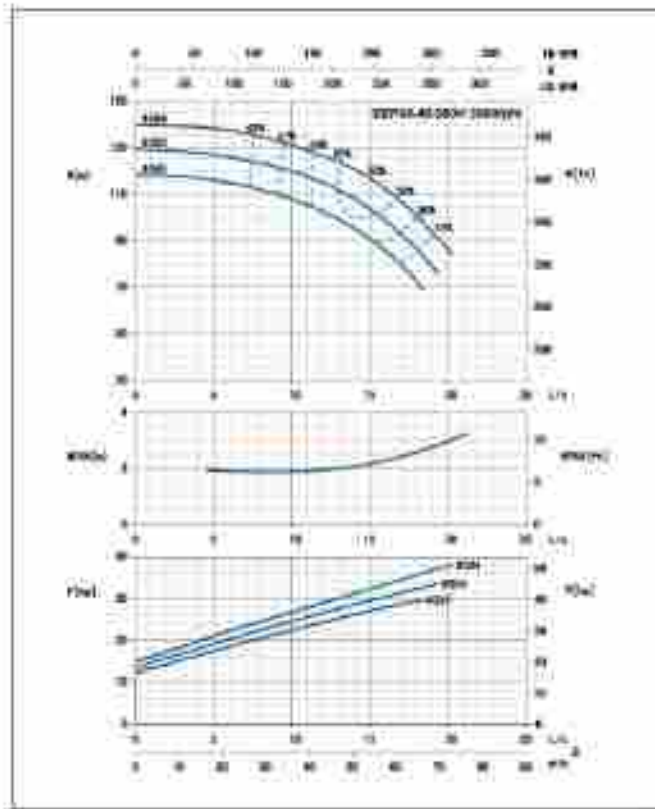

End Suction Centrifugal Pump

End Suction Centrifugal Pump

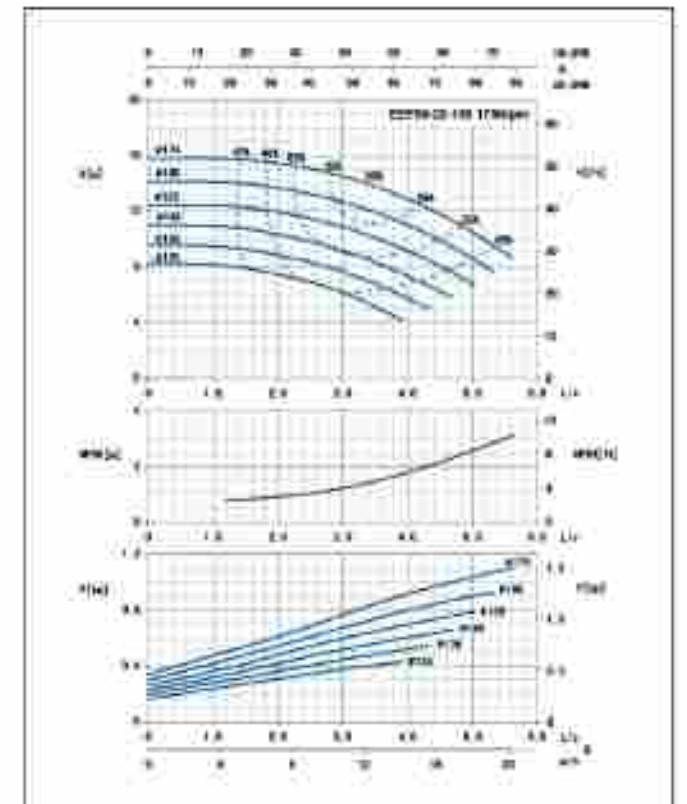
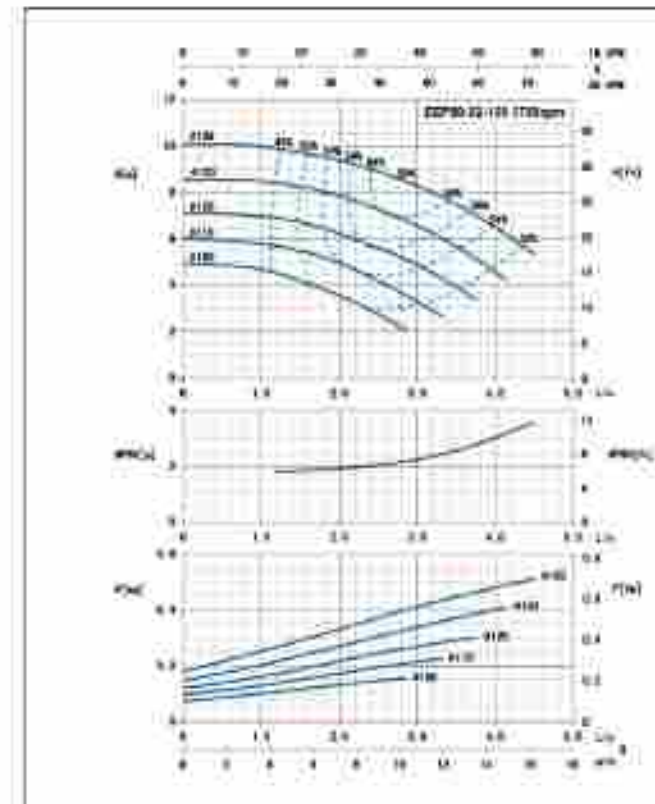
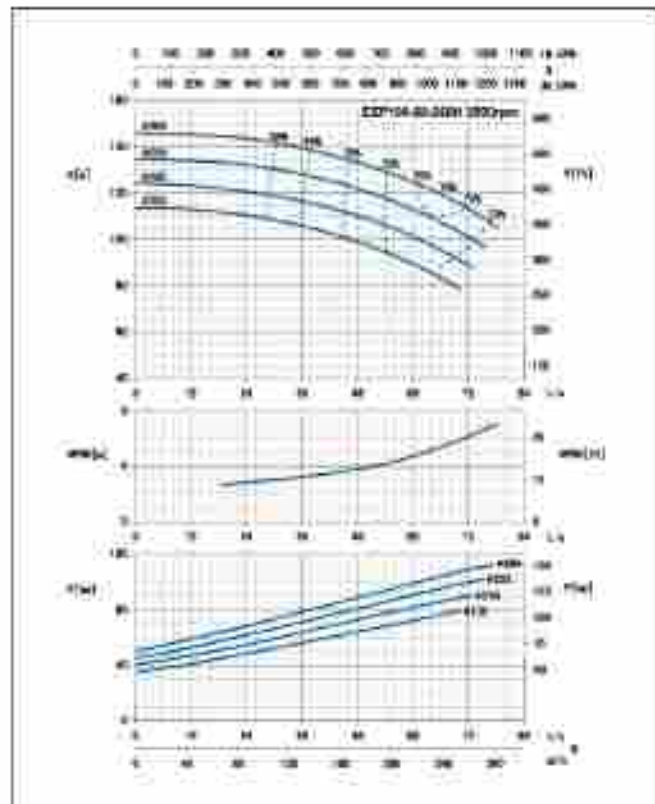
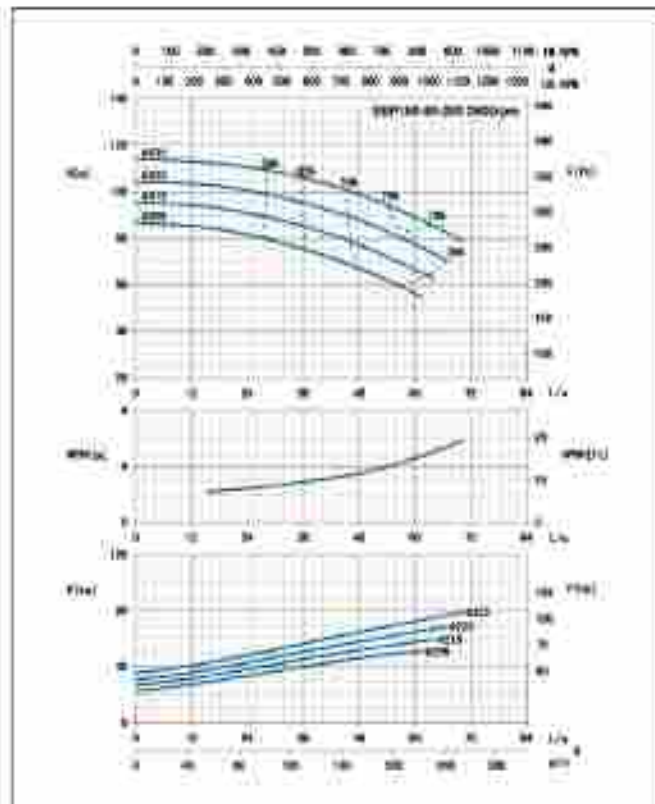
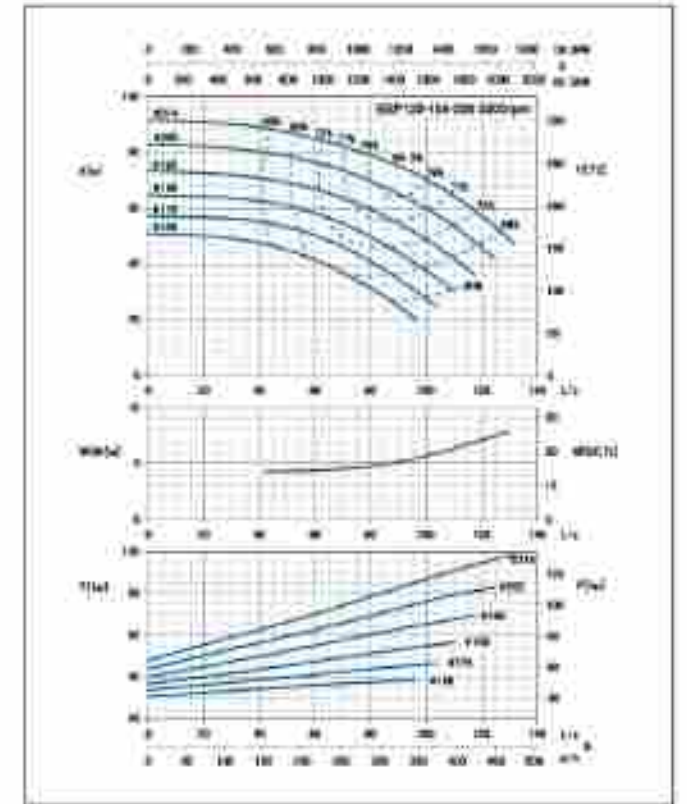
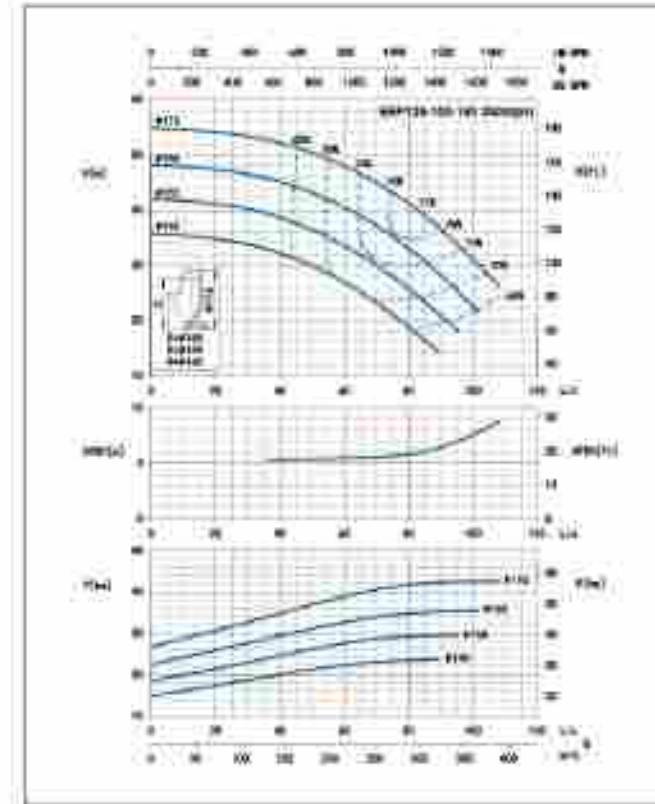
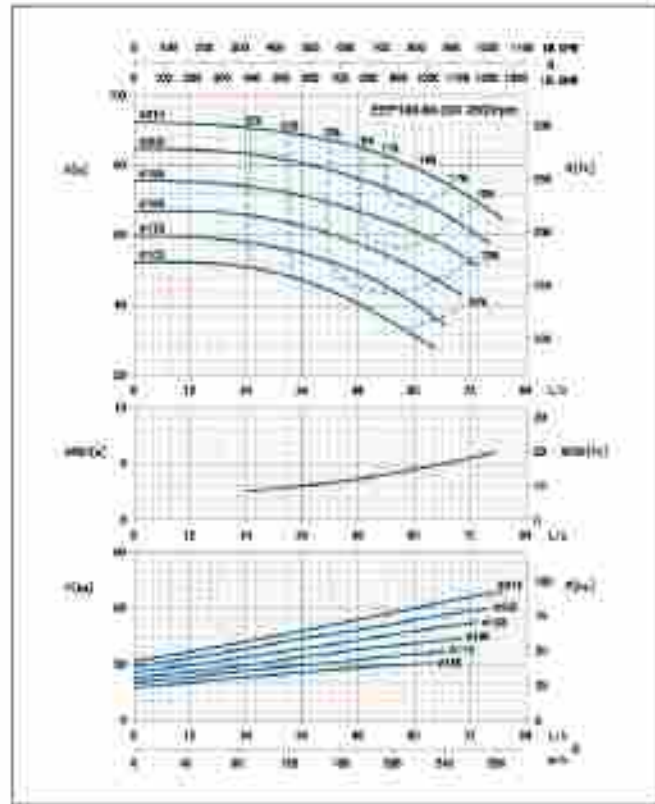
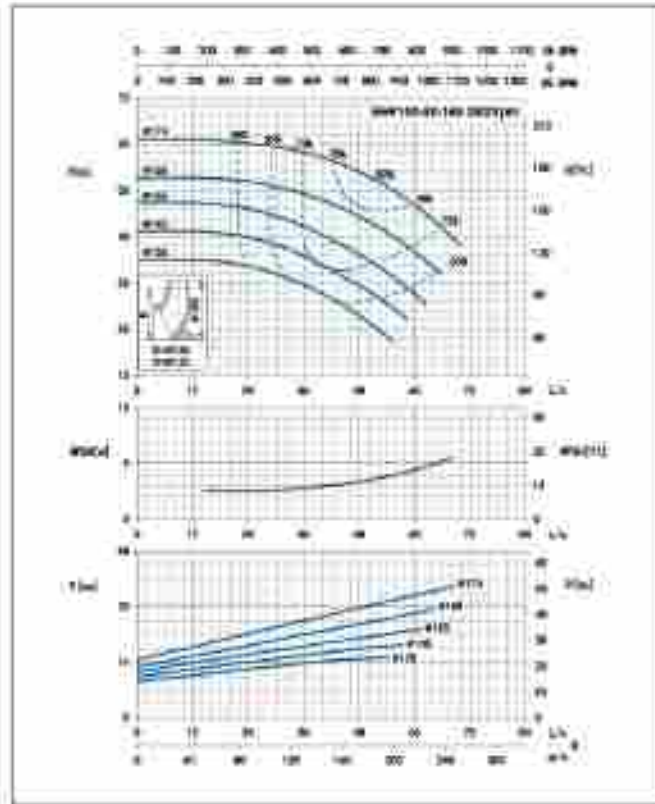

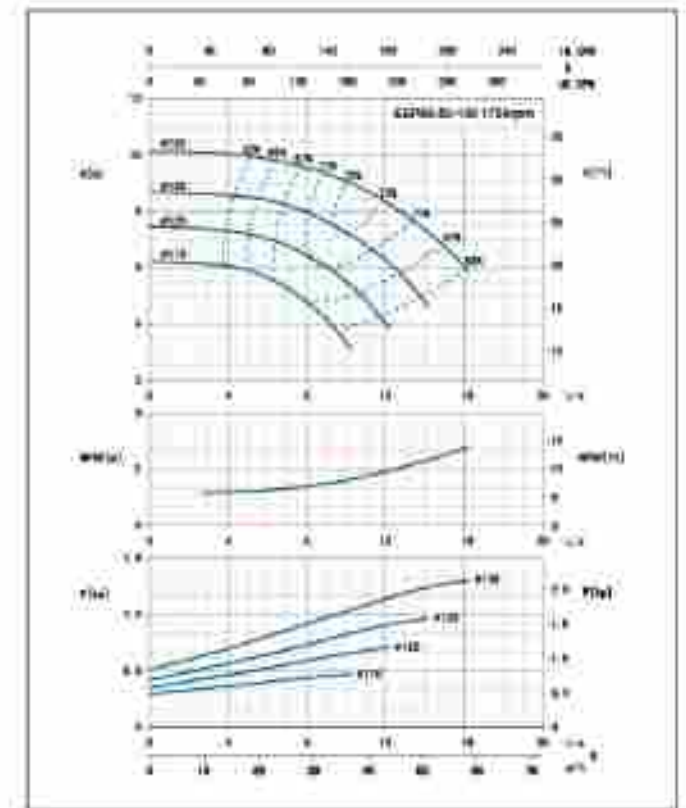
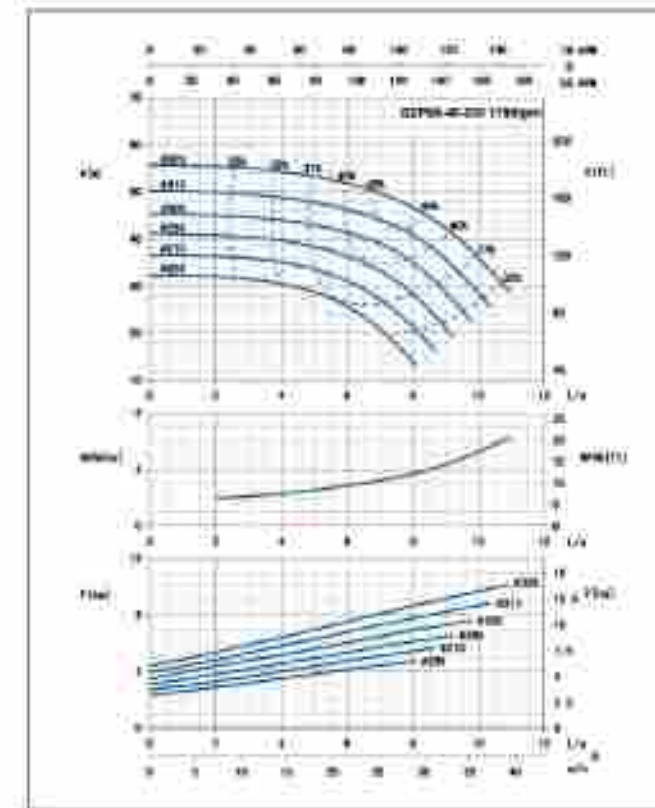
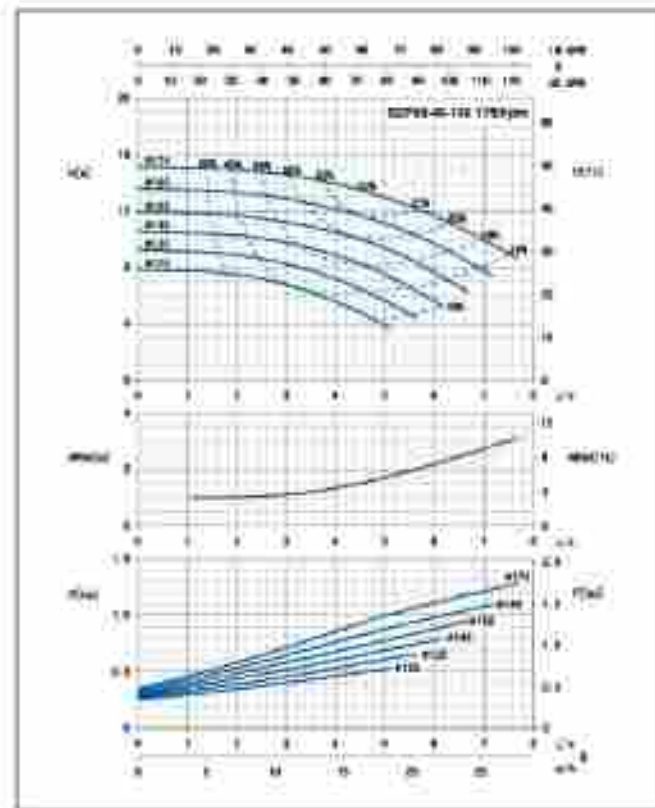
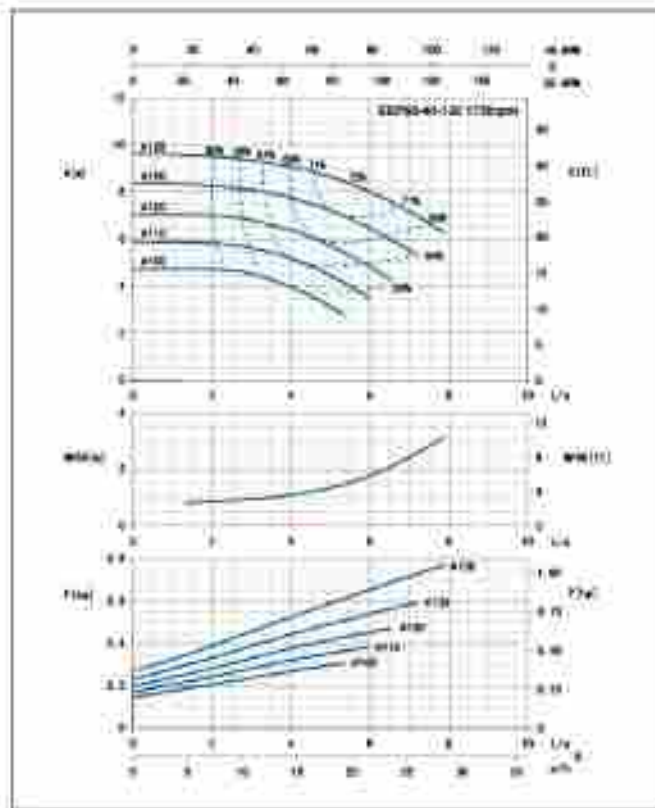
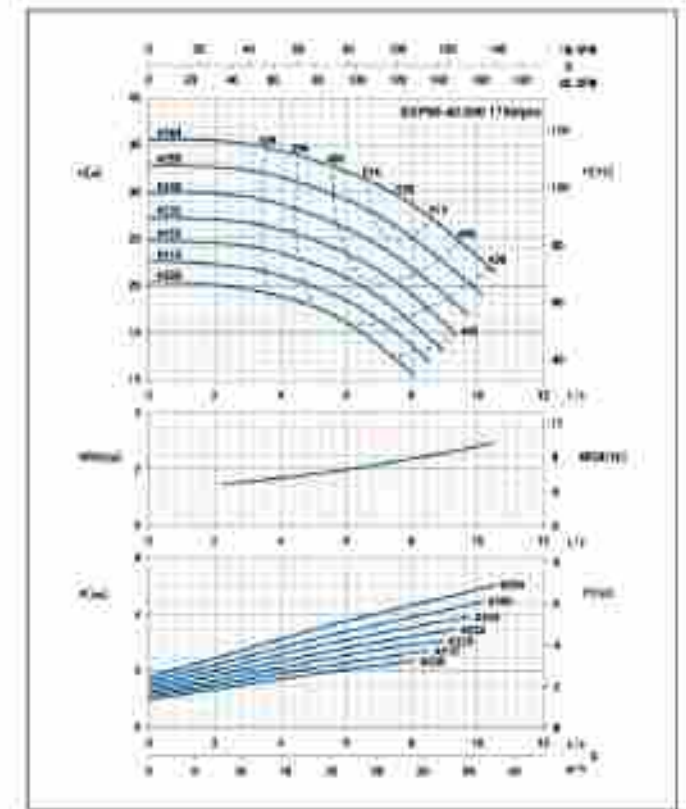
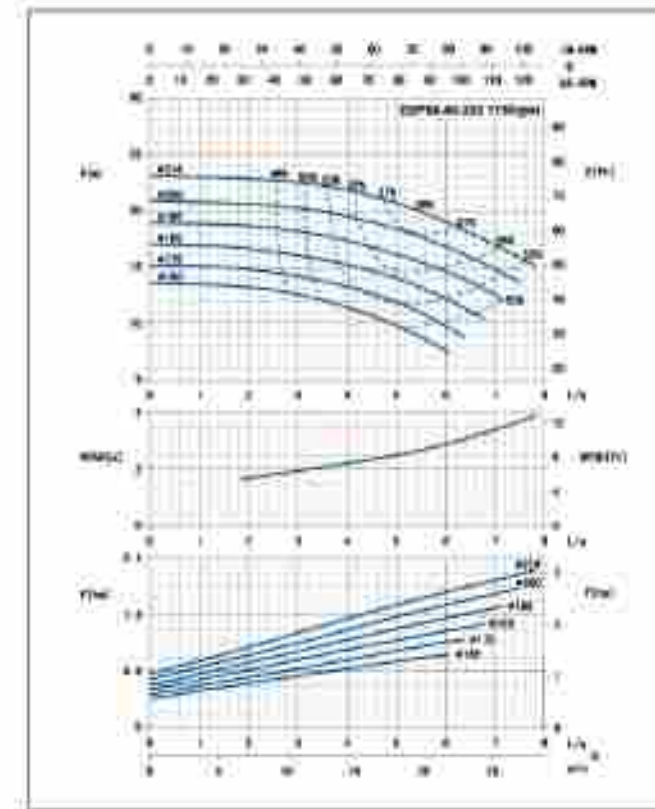
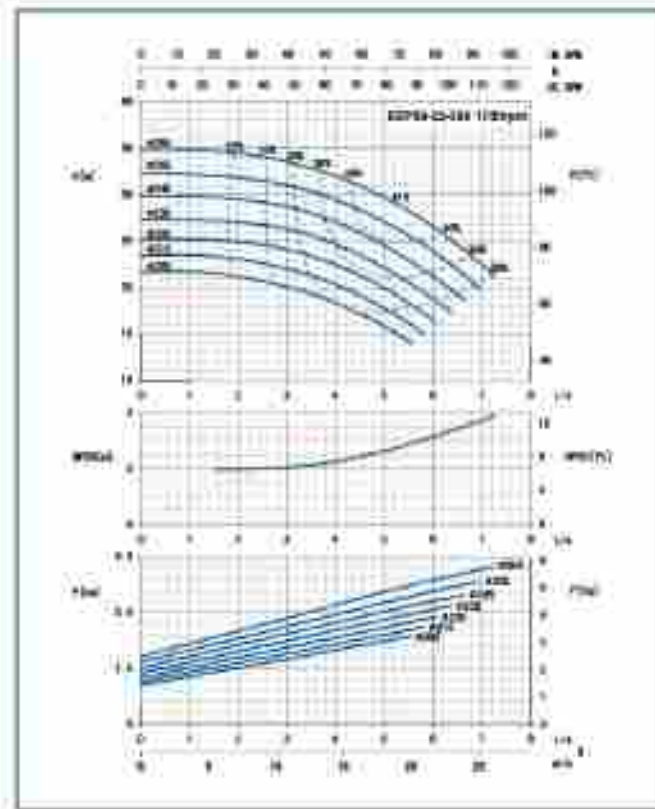
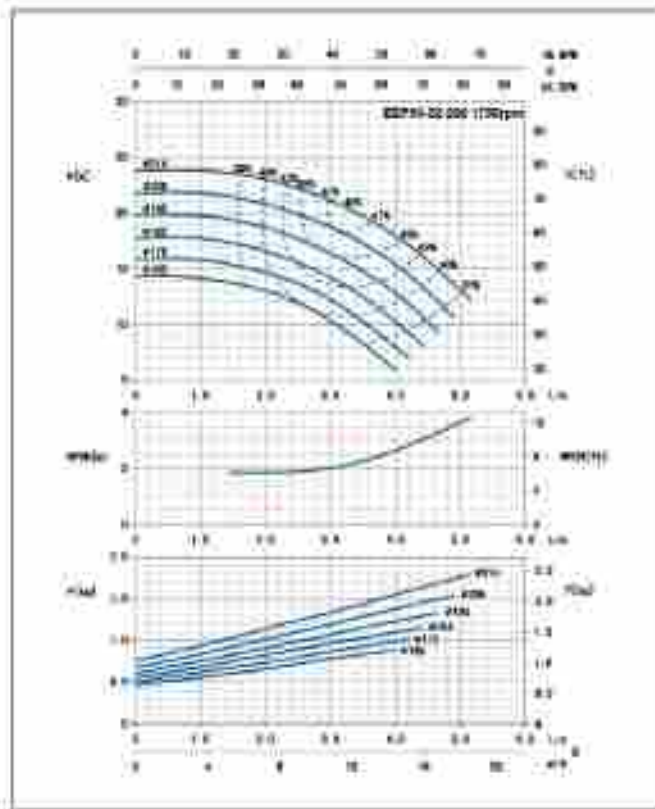

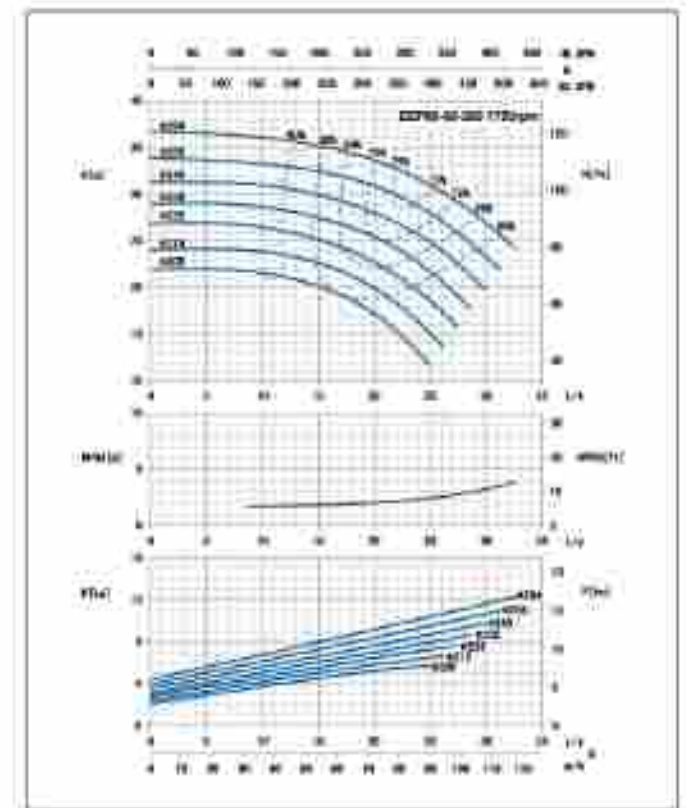
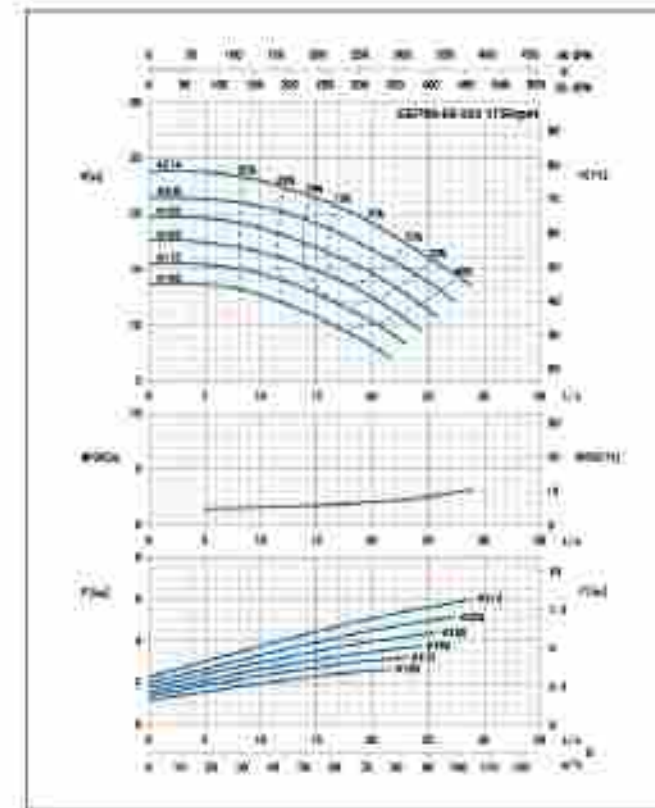
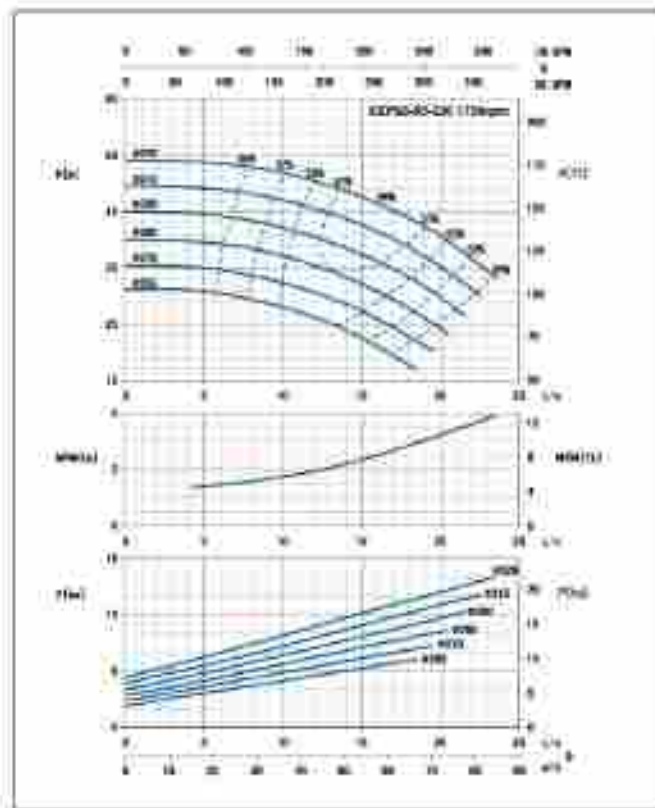
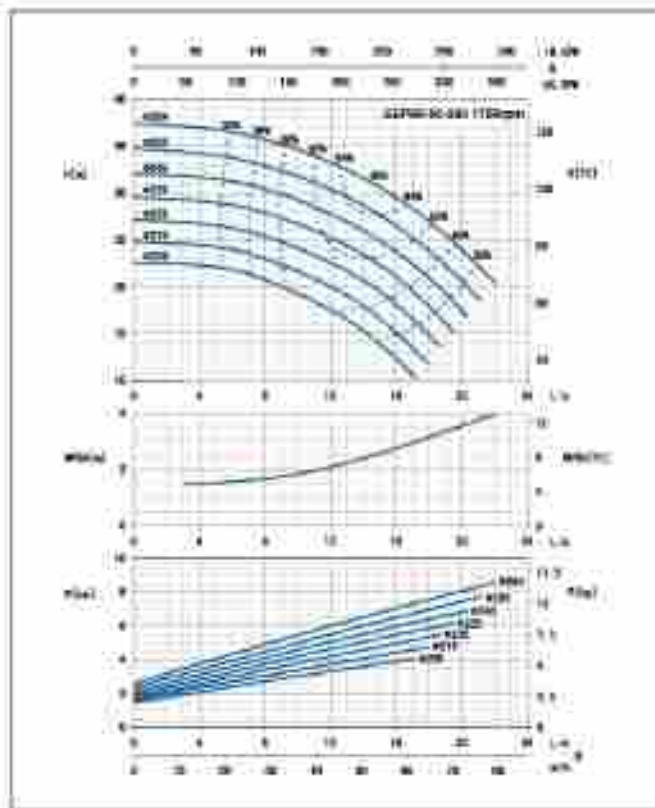
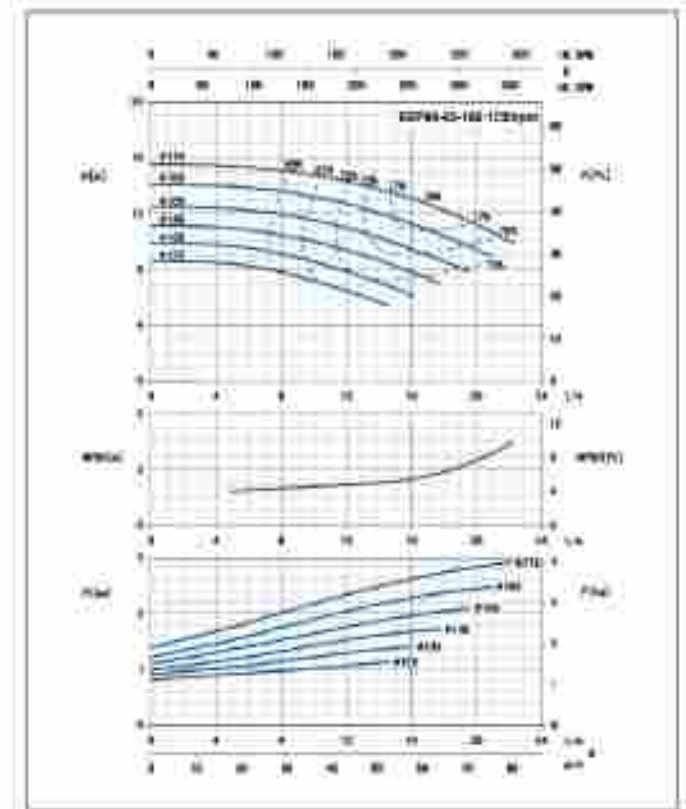
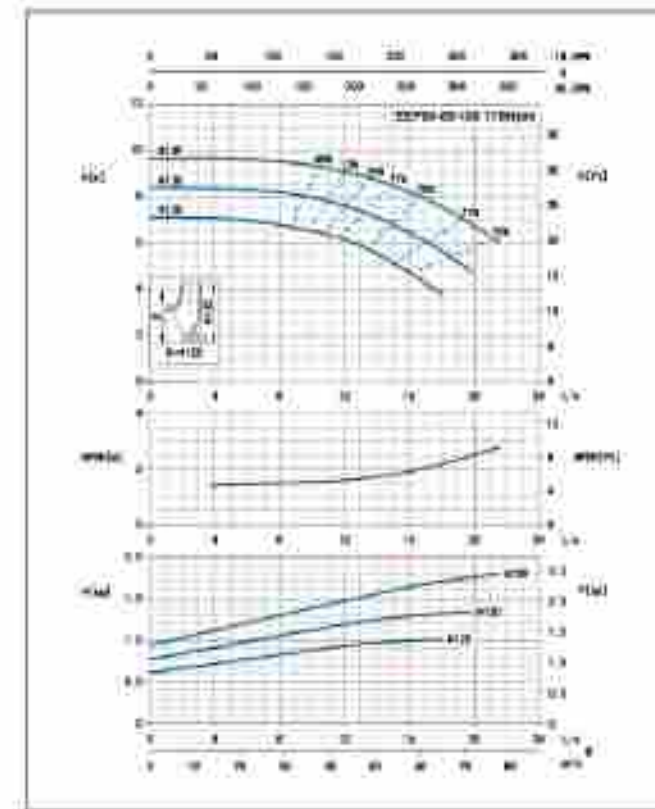
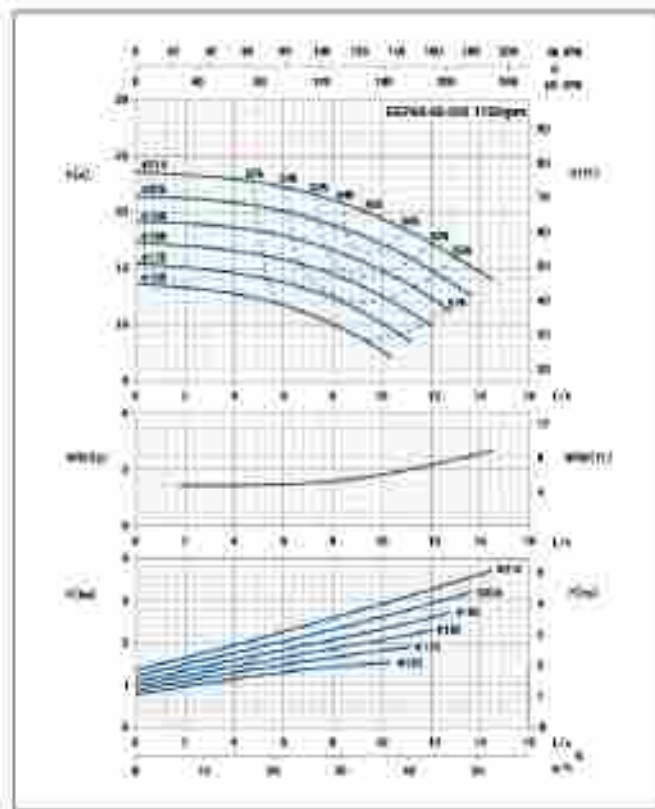
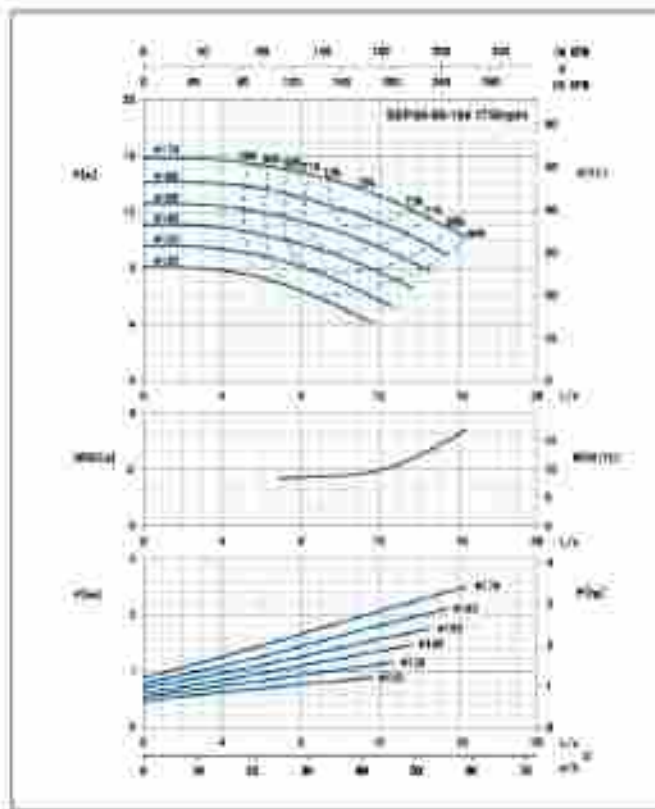

End Suction Centrifugal Pump

End Suction Centrifugal Pump

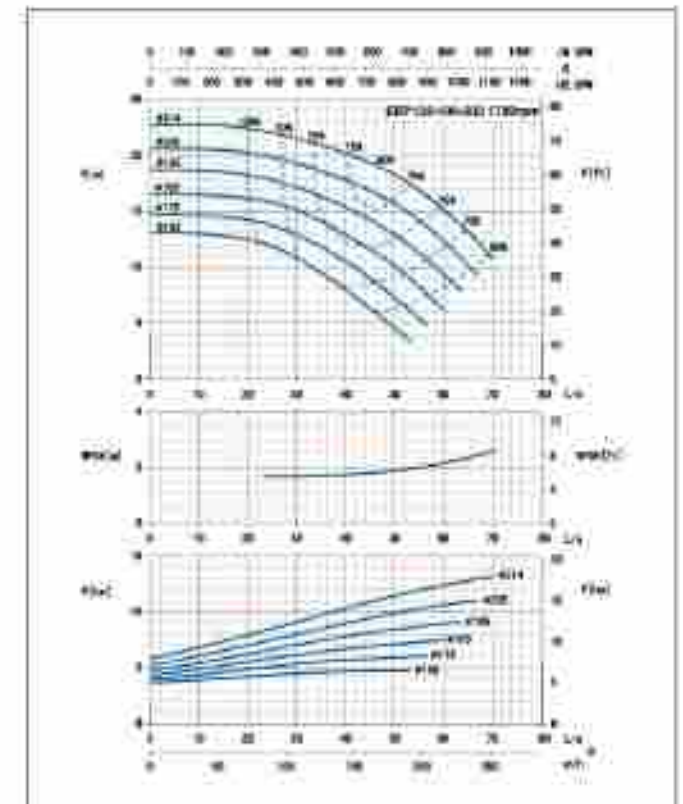
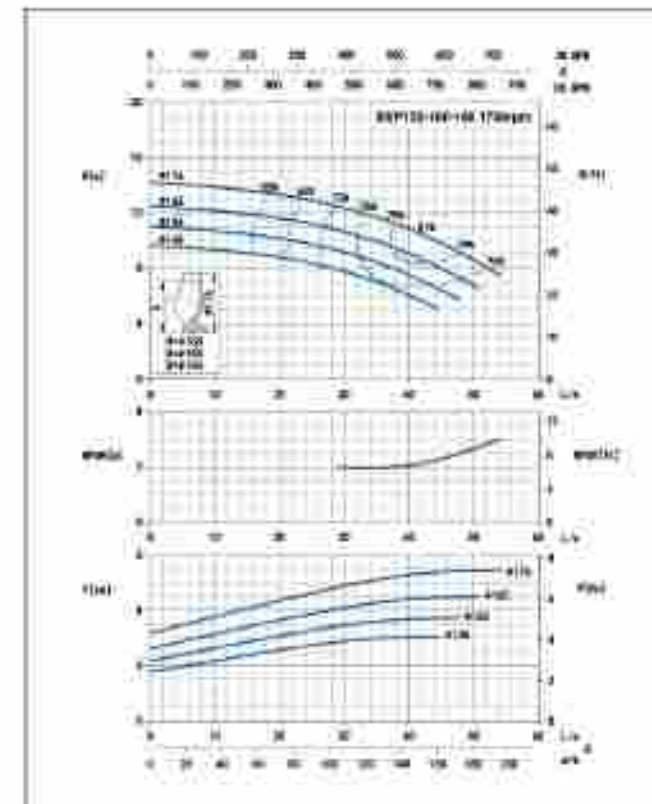
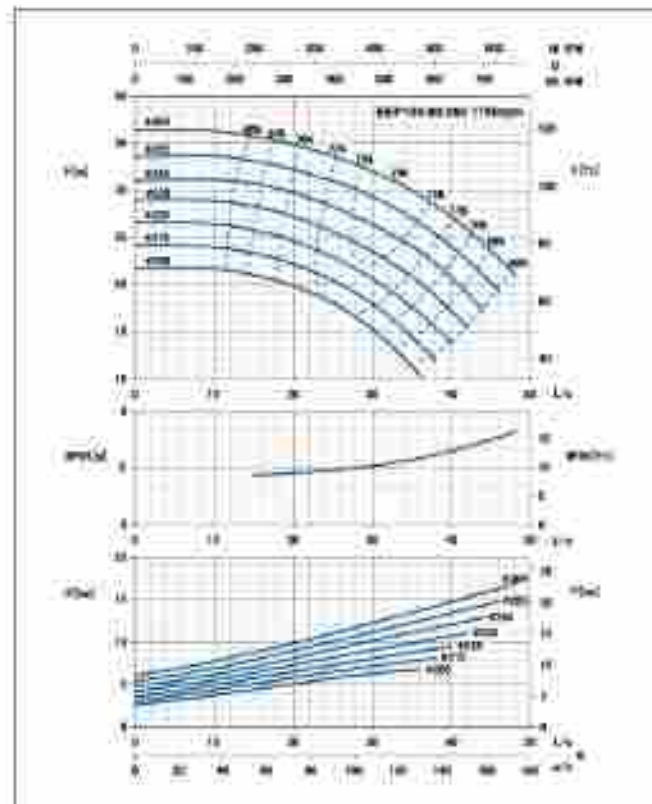
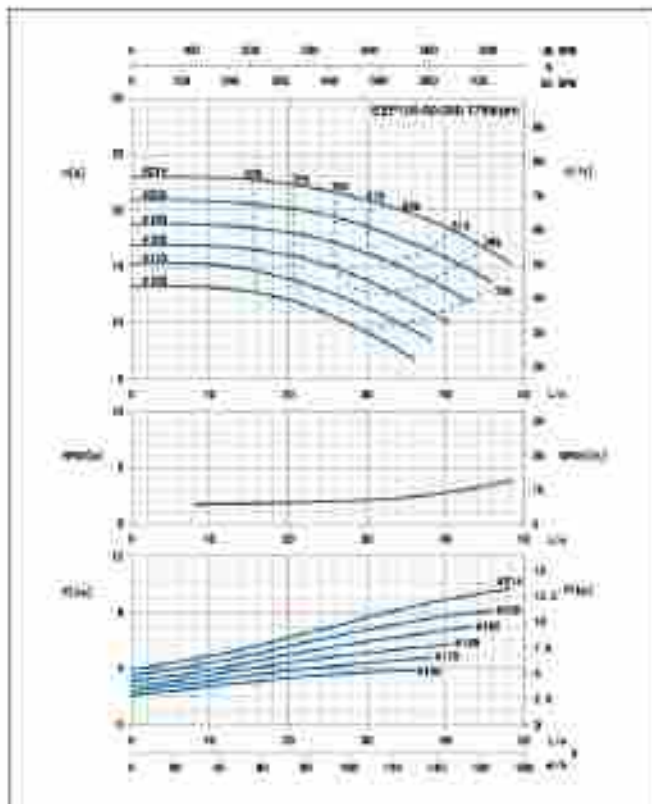
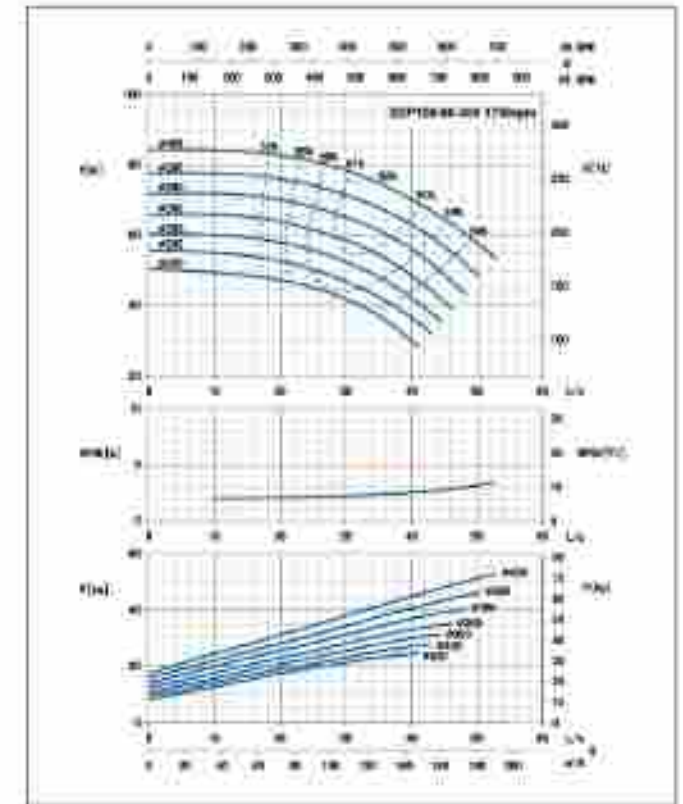
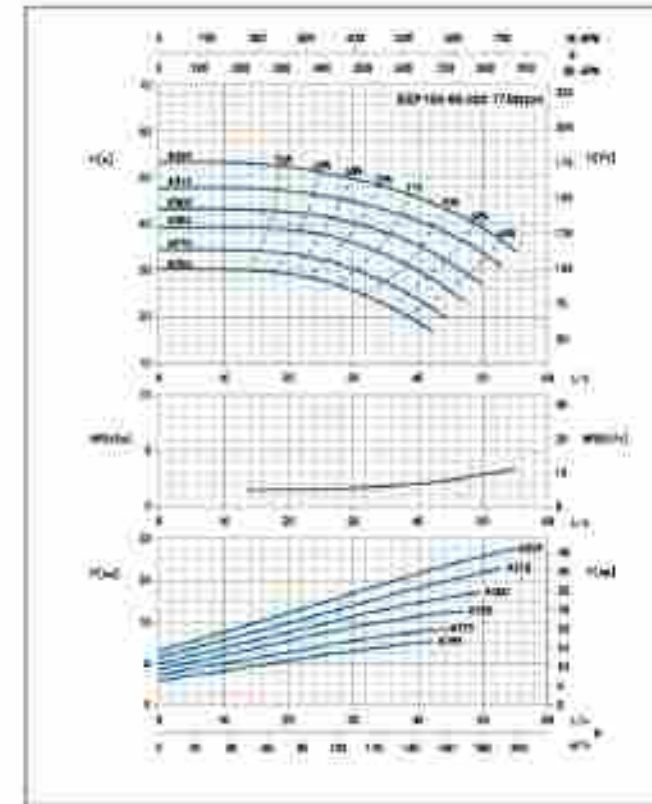
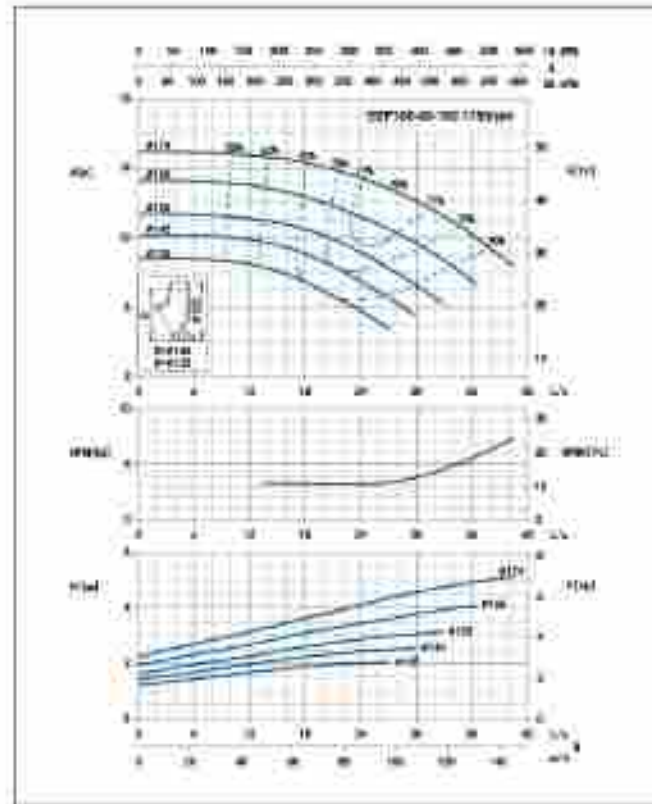
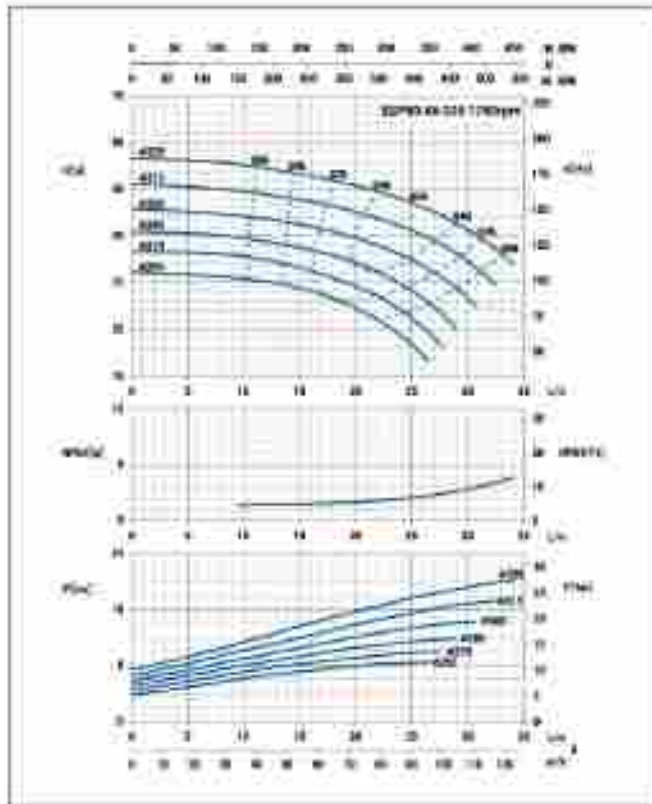

End Suction Centrifugal Pump

End Suction Centrifugal Pump

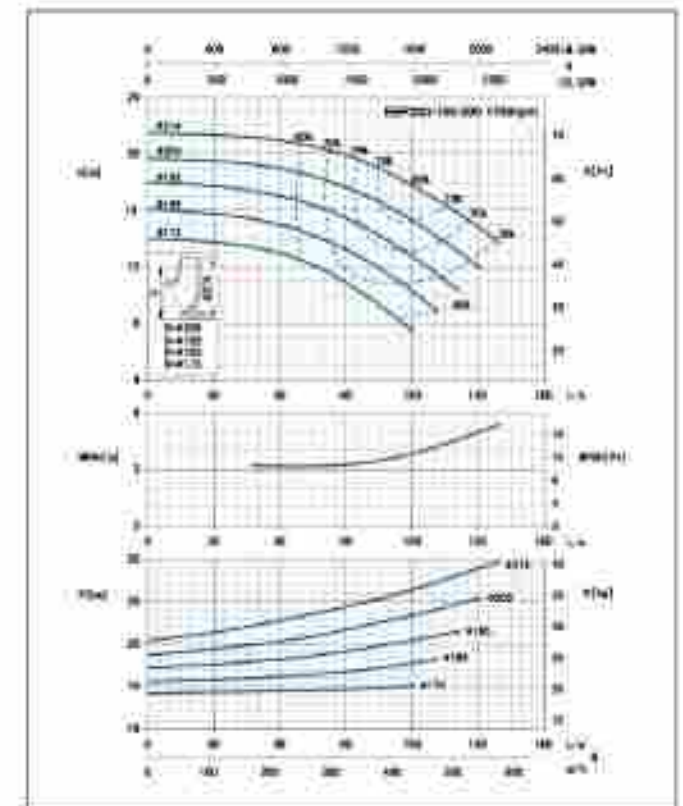
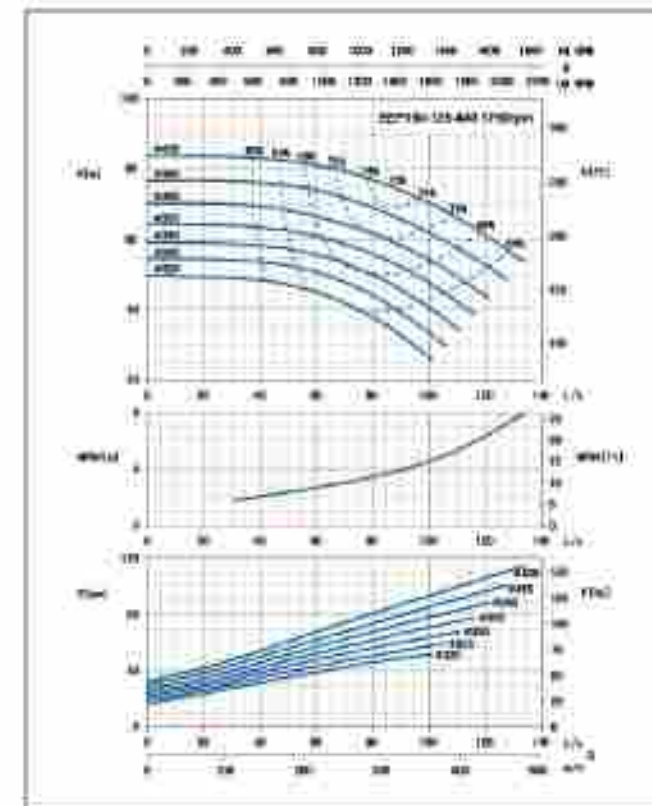
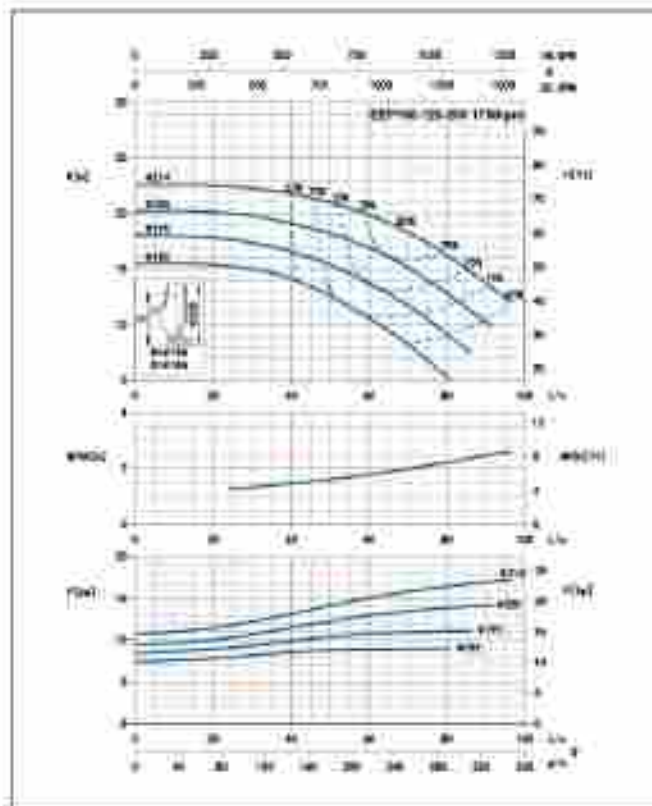
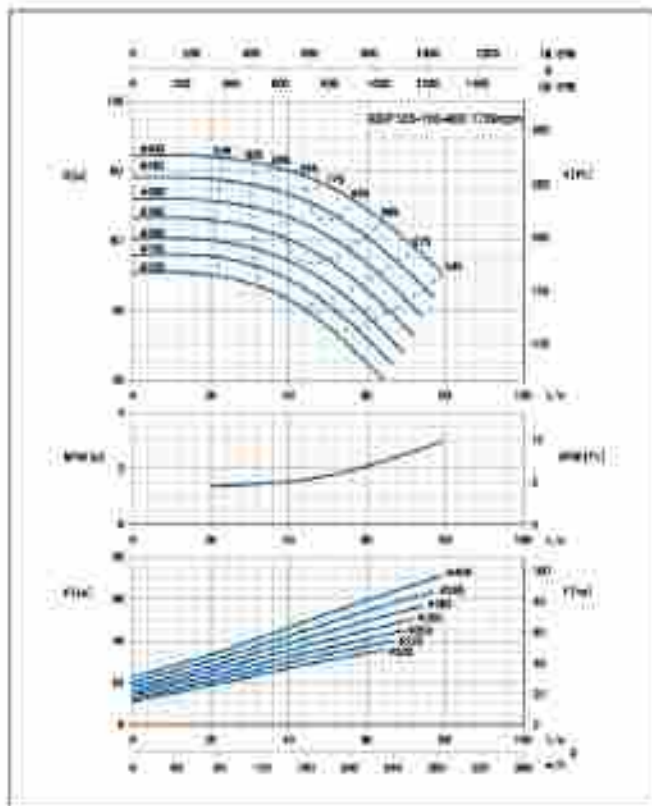
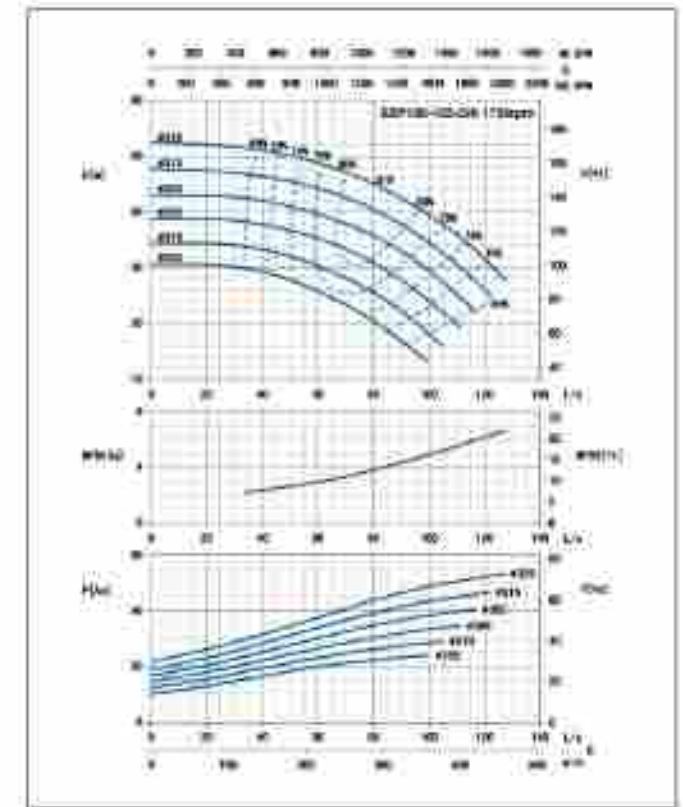
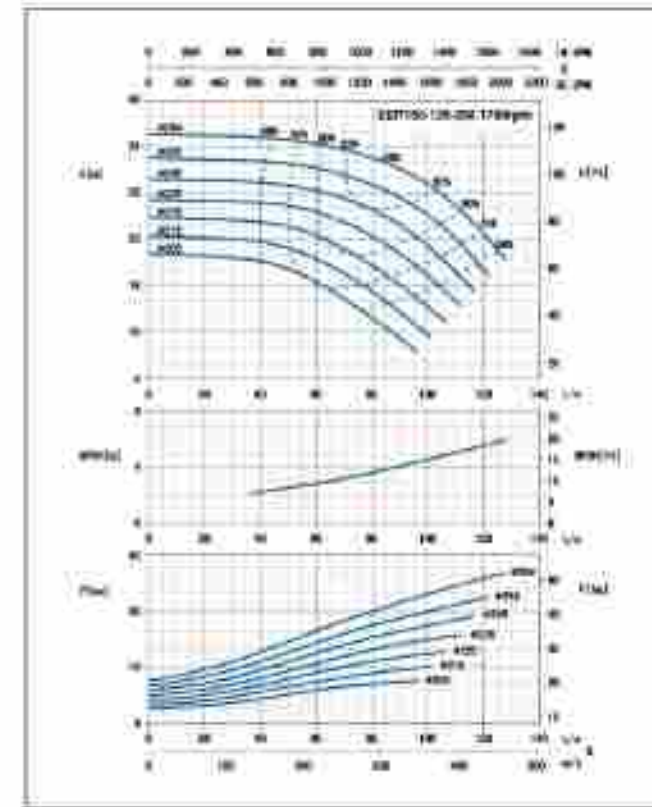
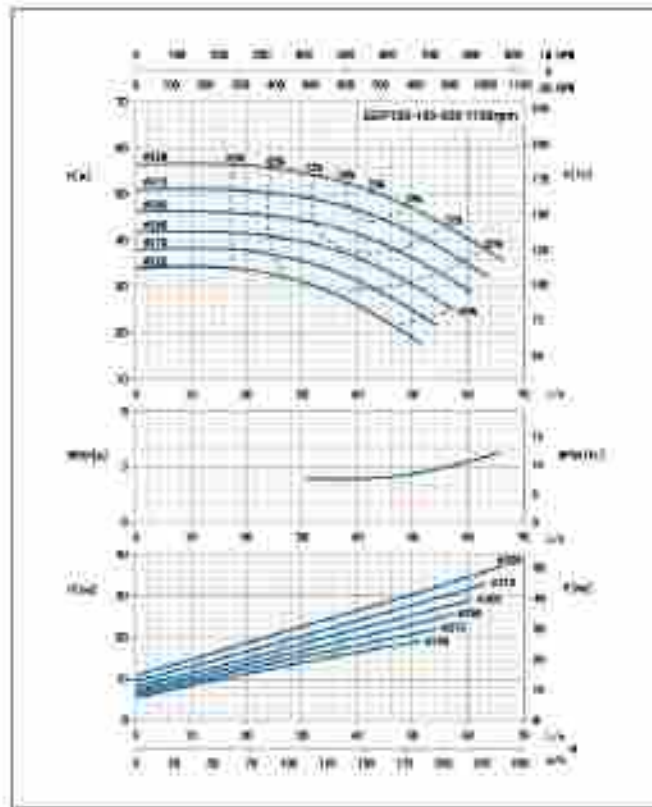
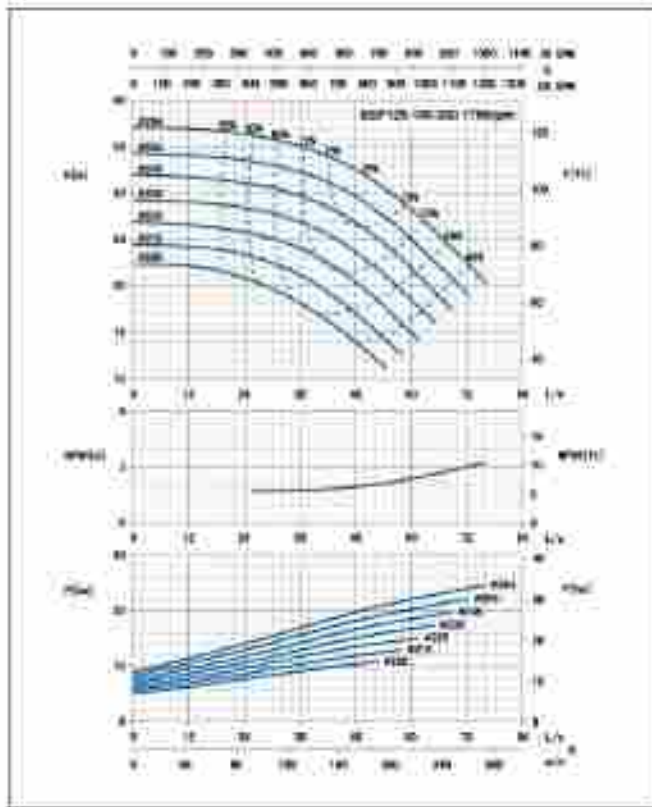

End Suction Centrifugal Pump

End Suction Centrifugal Pump

